

NOT FOR CONSTRUCTION

CONTRACTOR SHALL VERIFY ALL DIMENSIONS AND CONDITIONS OF EXISTING UTILITIES AND STRUCTURES PRIOR TO CONSTRUCTION. THE CONTRACTOR SHALL BE RESPONSIBLE FOR OBTAINING ALL NECESSARY PERMITS AND APPROVALS FROM THE APPROPRIATE AGENCIES. THE CONTRACTOR SHALL MAINTAIN ACCESS TO ALL ADJACENT PROPERTIES AND UTILITIES AT ALL TIMES. THE CONTRACTOR SHALL BE RESPONSIBLE FOR PROTECTING ALL EXISTING UTILITIES AND STRUCTURES FROM DAMAGE DURING CONSTRUCTION. THE CONTRACTOR SHALL MAINTAIN ALL NECESSARY RECORDS AND DOCUMENTATION THROUGHOUT THE PROJECT.

civil engineer
LAWRENCE J. PAGGI, P.E.
43 BROAD STREET
FISHKILL, NY 12524
845.897.2375 TEL
LJPAGGI@OPTONLINE.NET

CONSULTANT SEAL

NOT FOR CONSTRUCTION



PROJECT NAME:
**CENTRAL HUDSON
GAS & ELECTRIC
CORPORATION
TRAINING CENTER**

PROJECT ADDRESS:
**2229 ULSTER AVE
(ROUTE 9W)
LAKE KATRINE,
NEW YORK 12449
TOWN OF ULSTER**

NO.	REVISIONS	BY	DATE

ISSUED FOR	ISSUED DATE	CHECKED BY	DATE
PLANNING BOARD SUBMISSION	07/30/2019	LJP	LJP

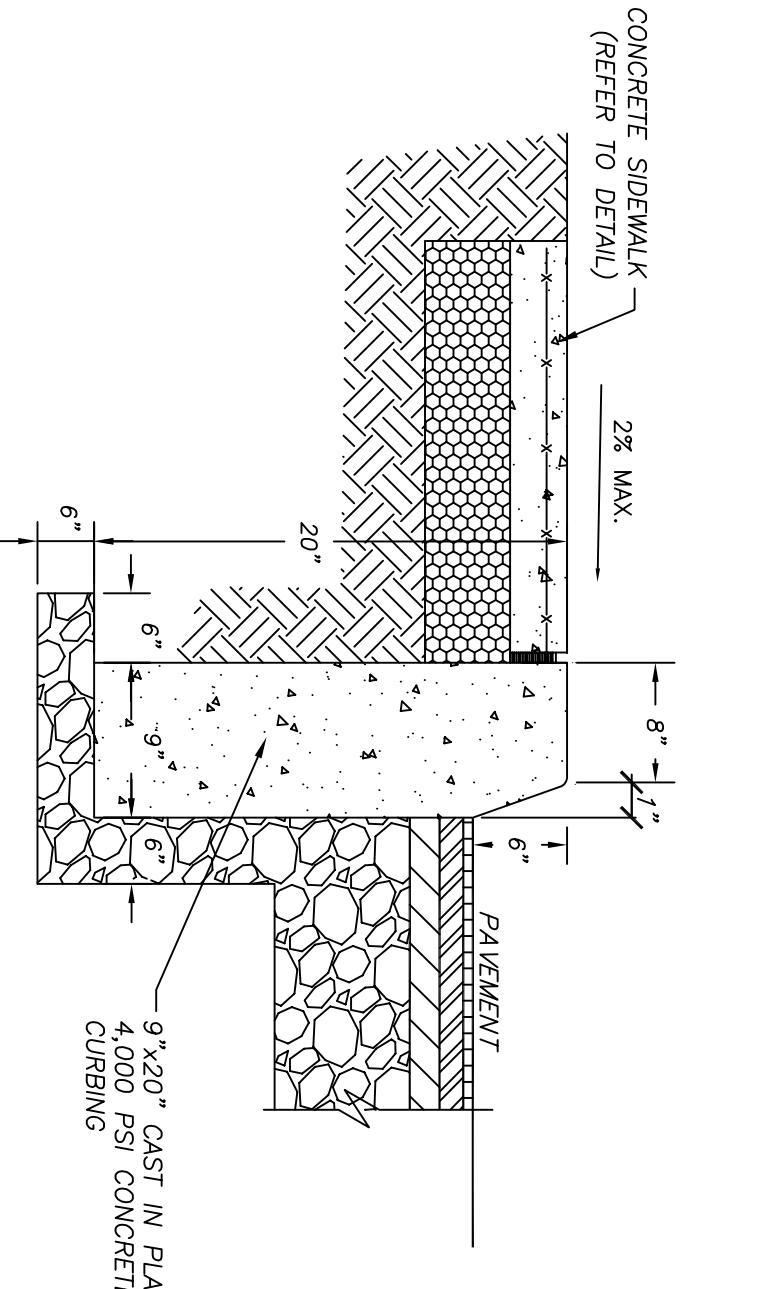

CONCRETE CURB DETAIL
NOT TO SCALE

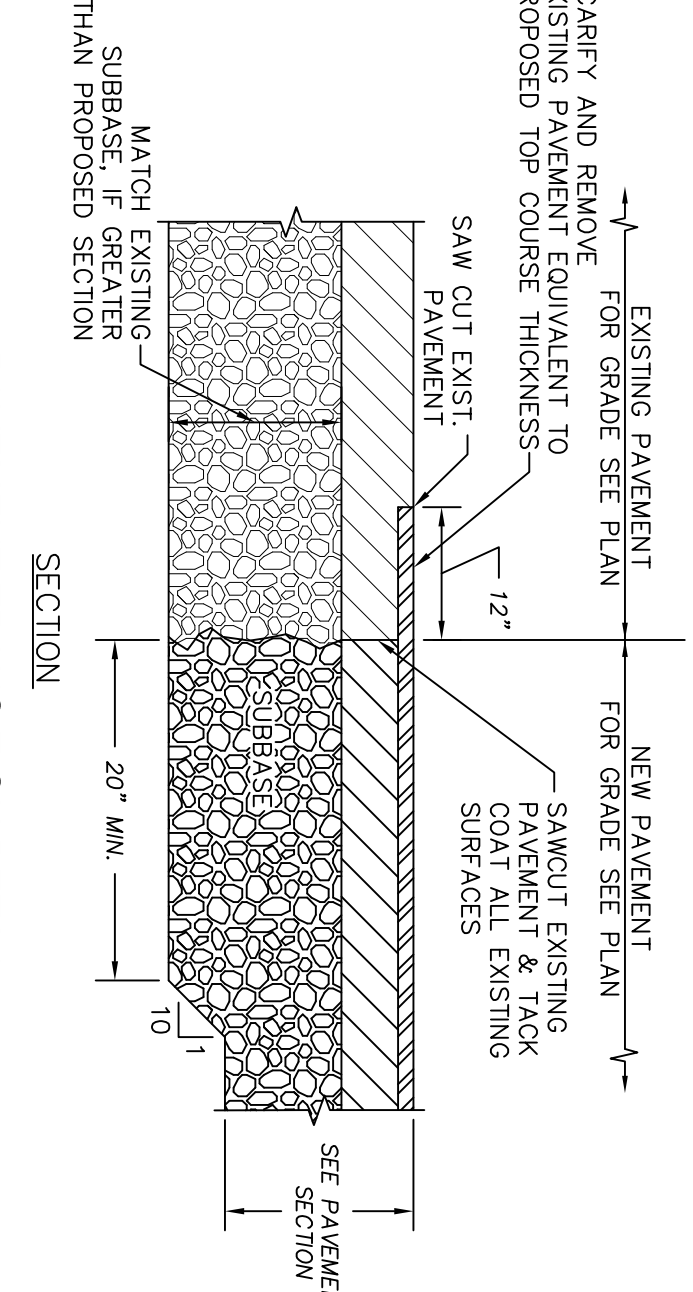

PAVEMENT TRANSITION DETAIL
NOT TO SCALE

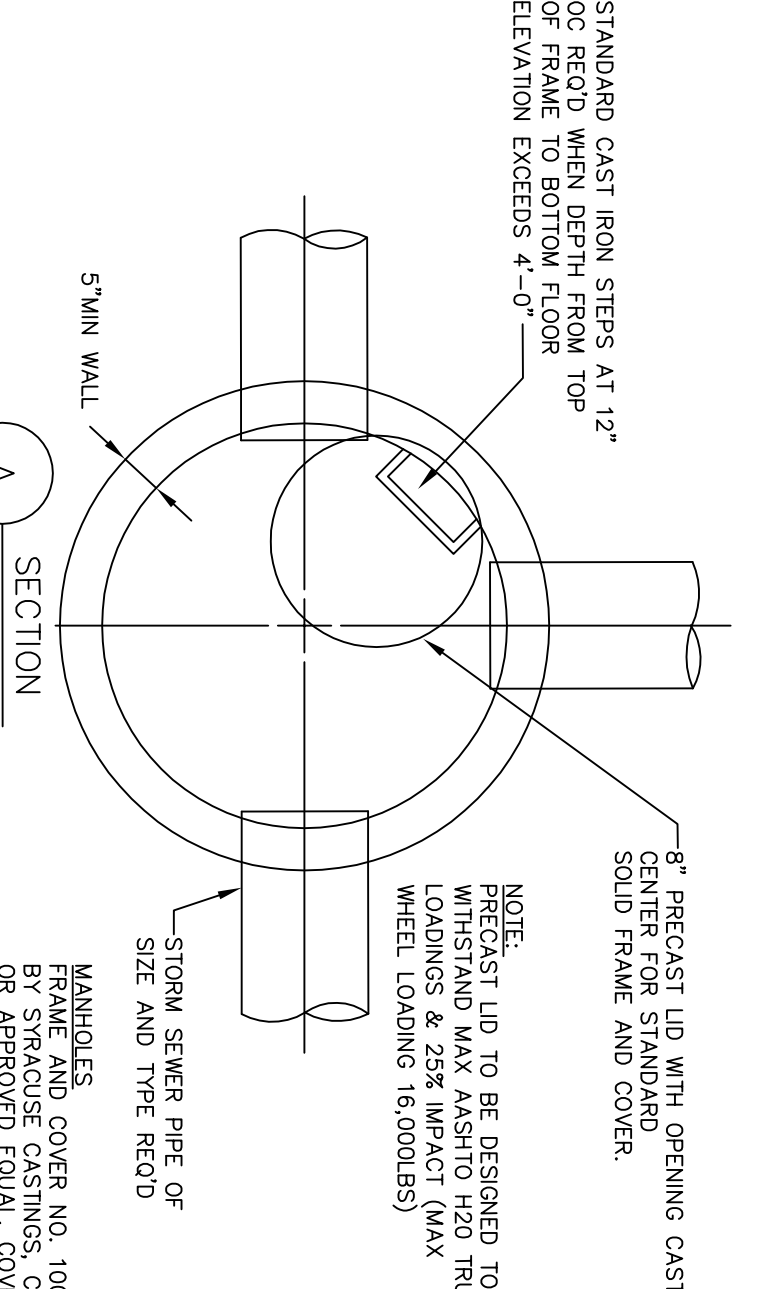

**PRECAST CONCRETE STORM SEWER
MANHOLE DETAIL**
NOT TO SCALE

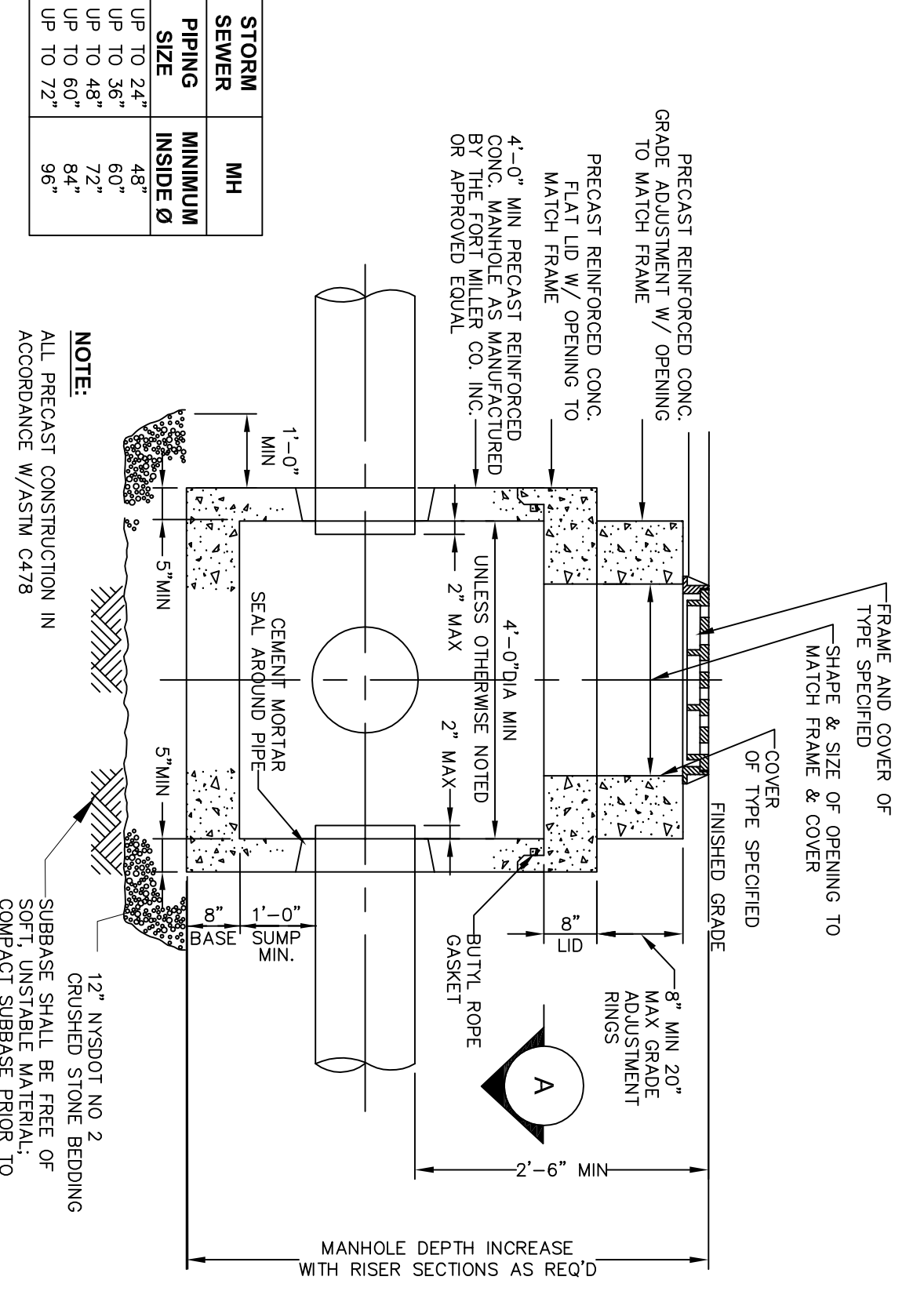

TYPICAL SECTION

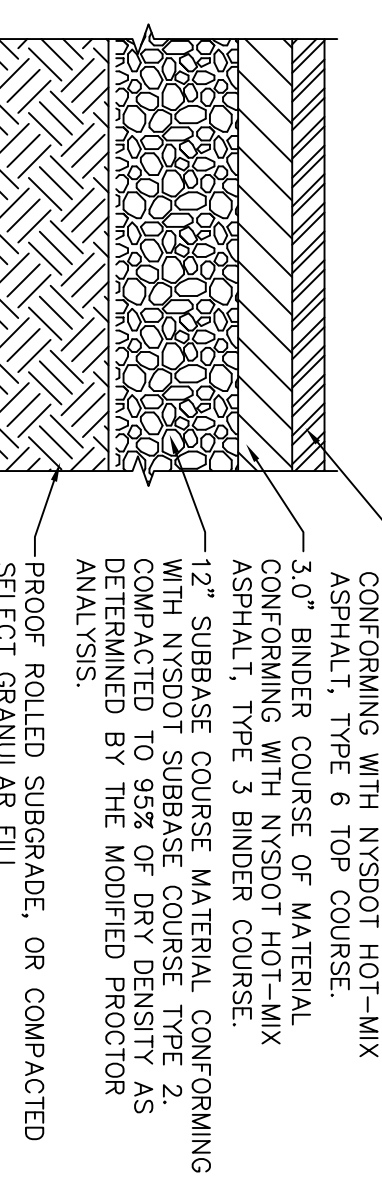

PAVEMENT STRUCTURE DETAIL
NOT TO SCALE

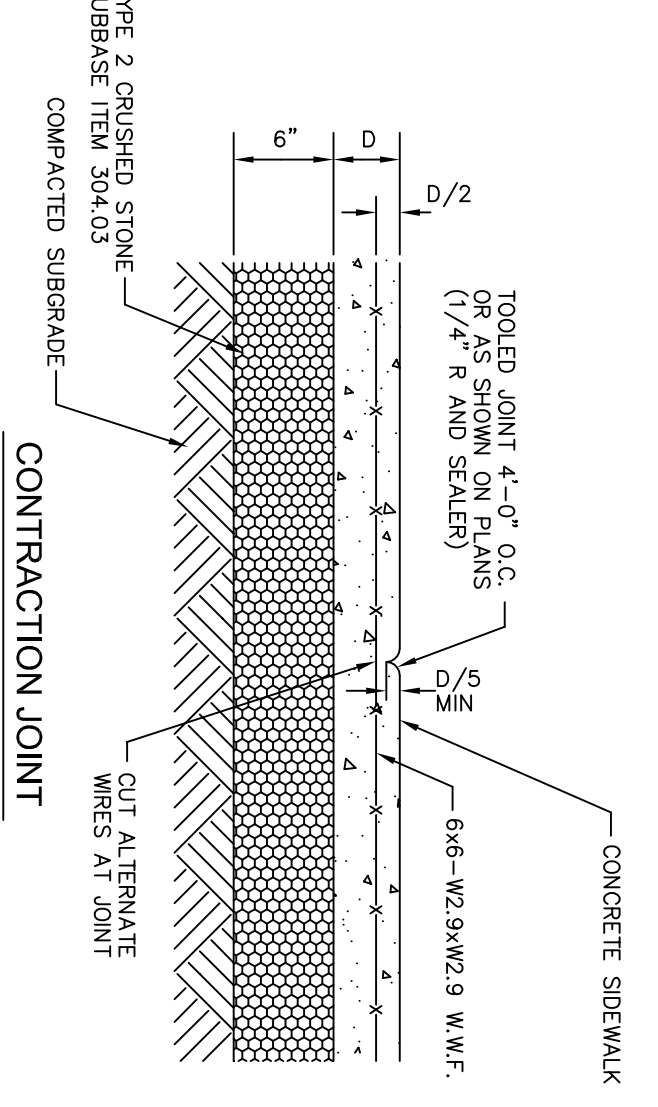

CONCRETE SIDEWALK DETAIL
NOT TO SCALE

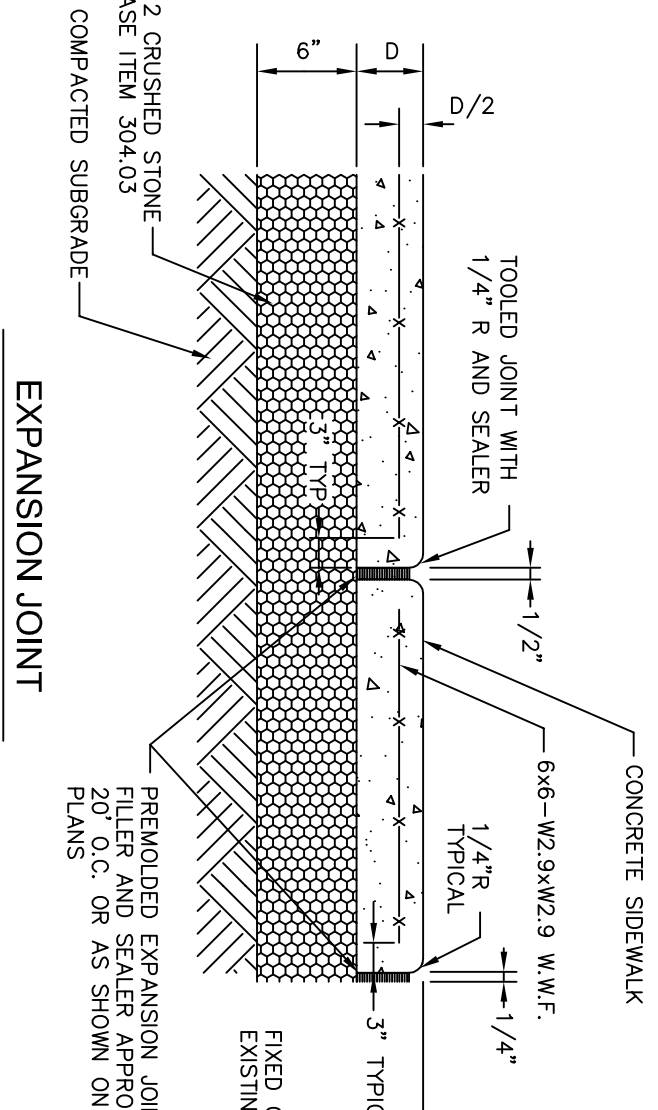

CONCRETE SIDEWALK DETAIL
NOT TO SCALE

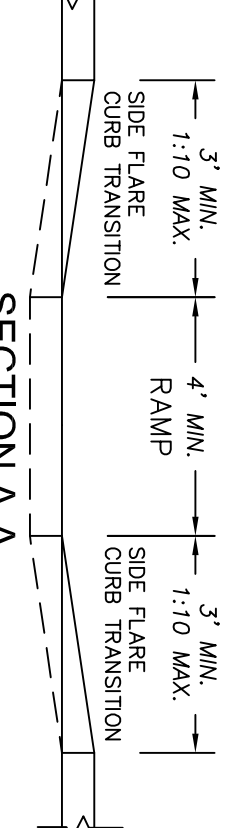

SECTION AA

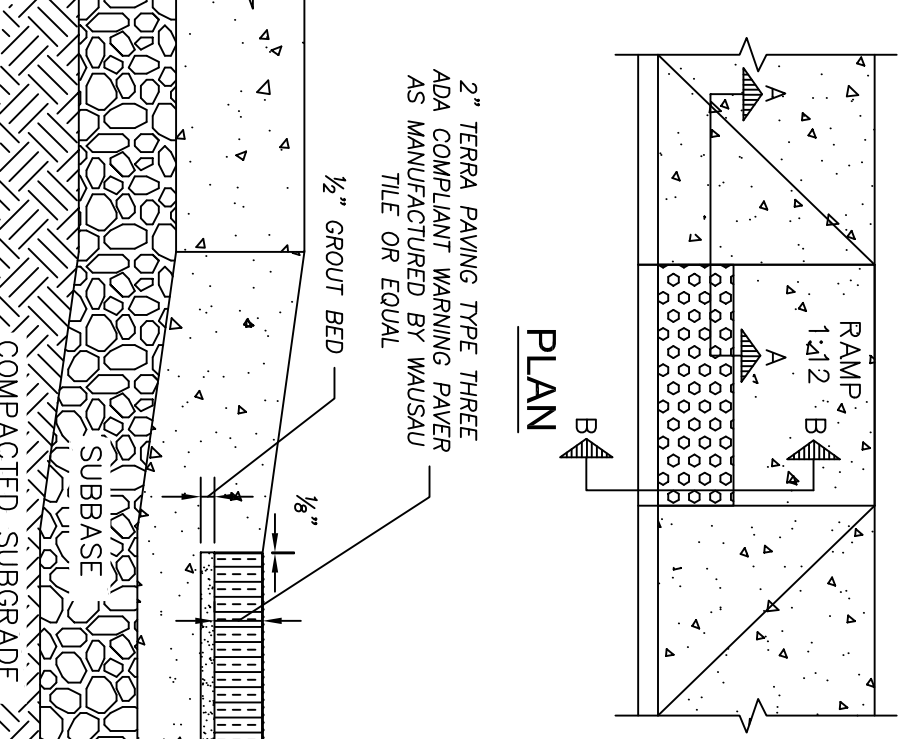

SECTION AA THRU RAMP

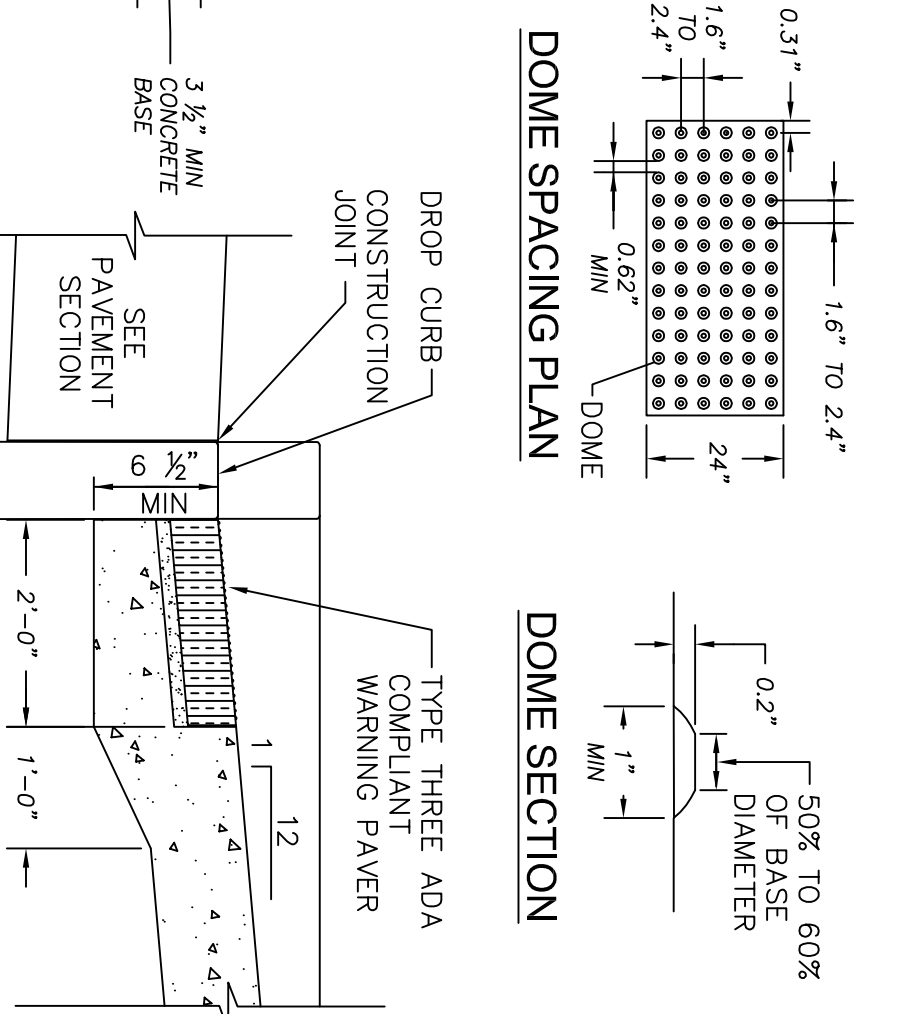

SECTION B-B THRU RAMP

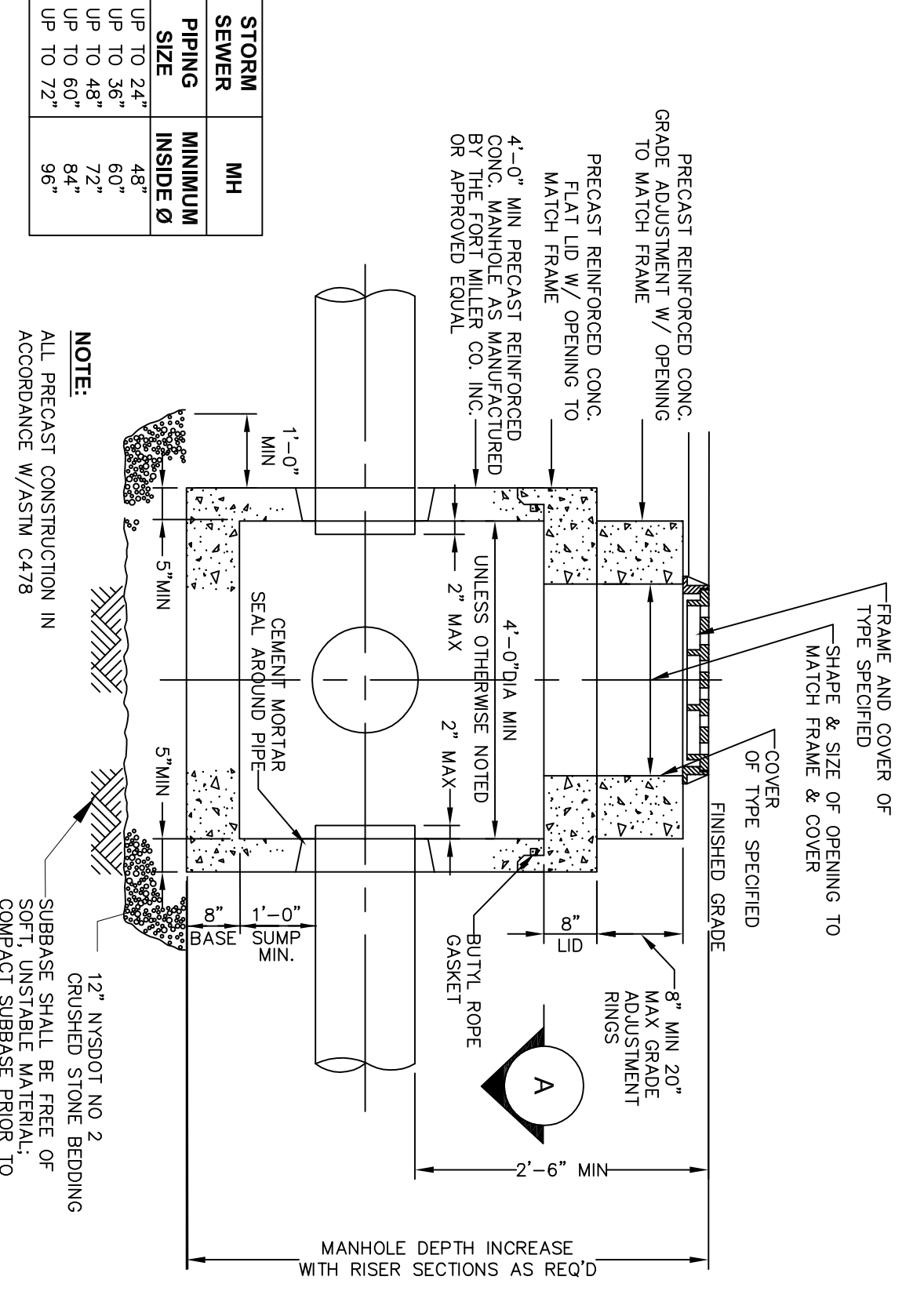

**PRECAST CONCRETE STORM SEWER
MANHOLE DETAIL**
NOT TO SCALE

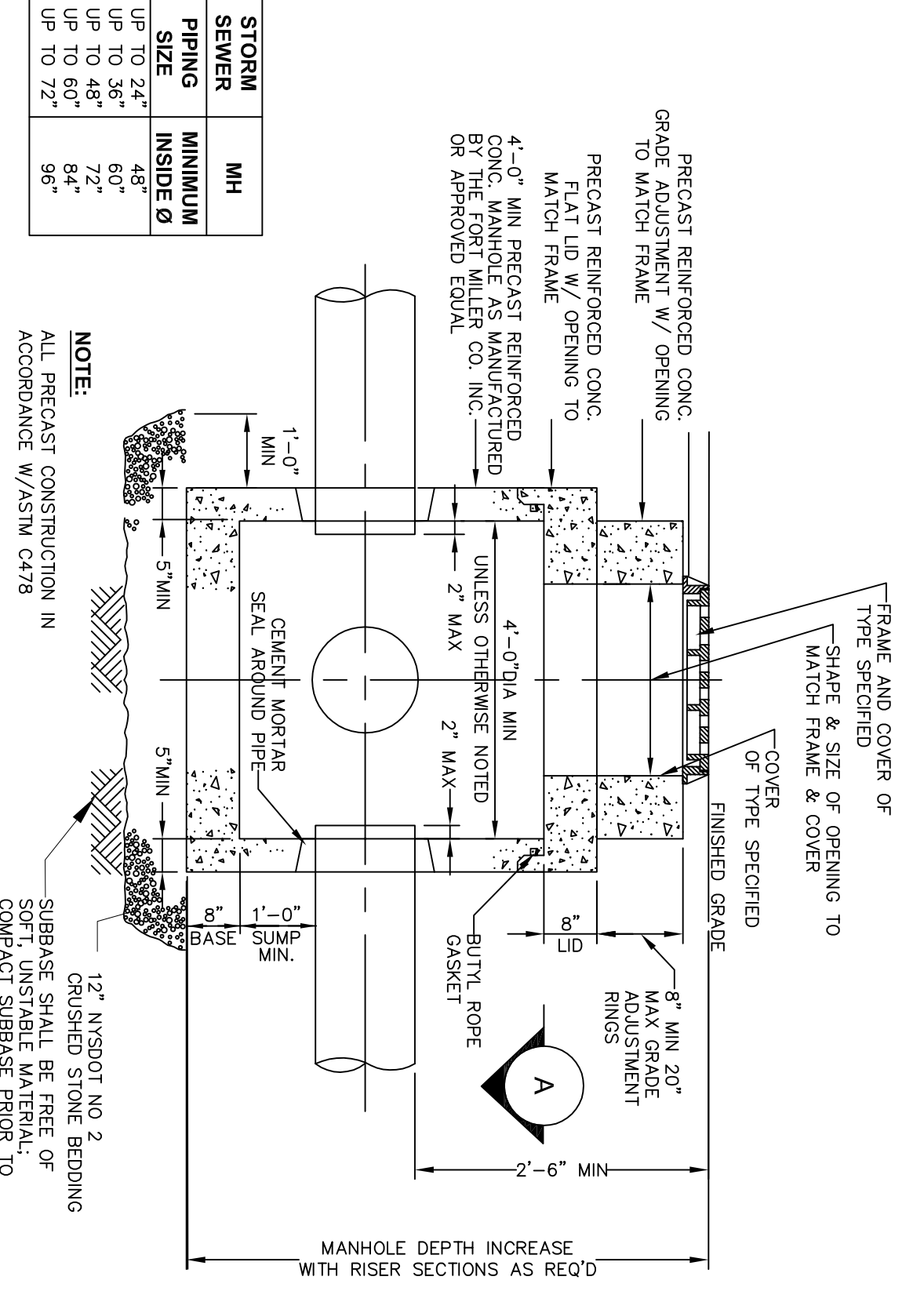

**PRECAST CONCRETE STORM SEWER
MANHOLE DETAIL**
NOT TO SCALE

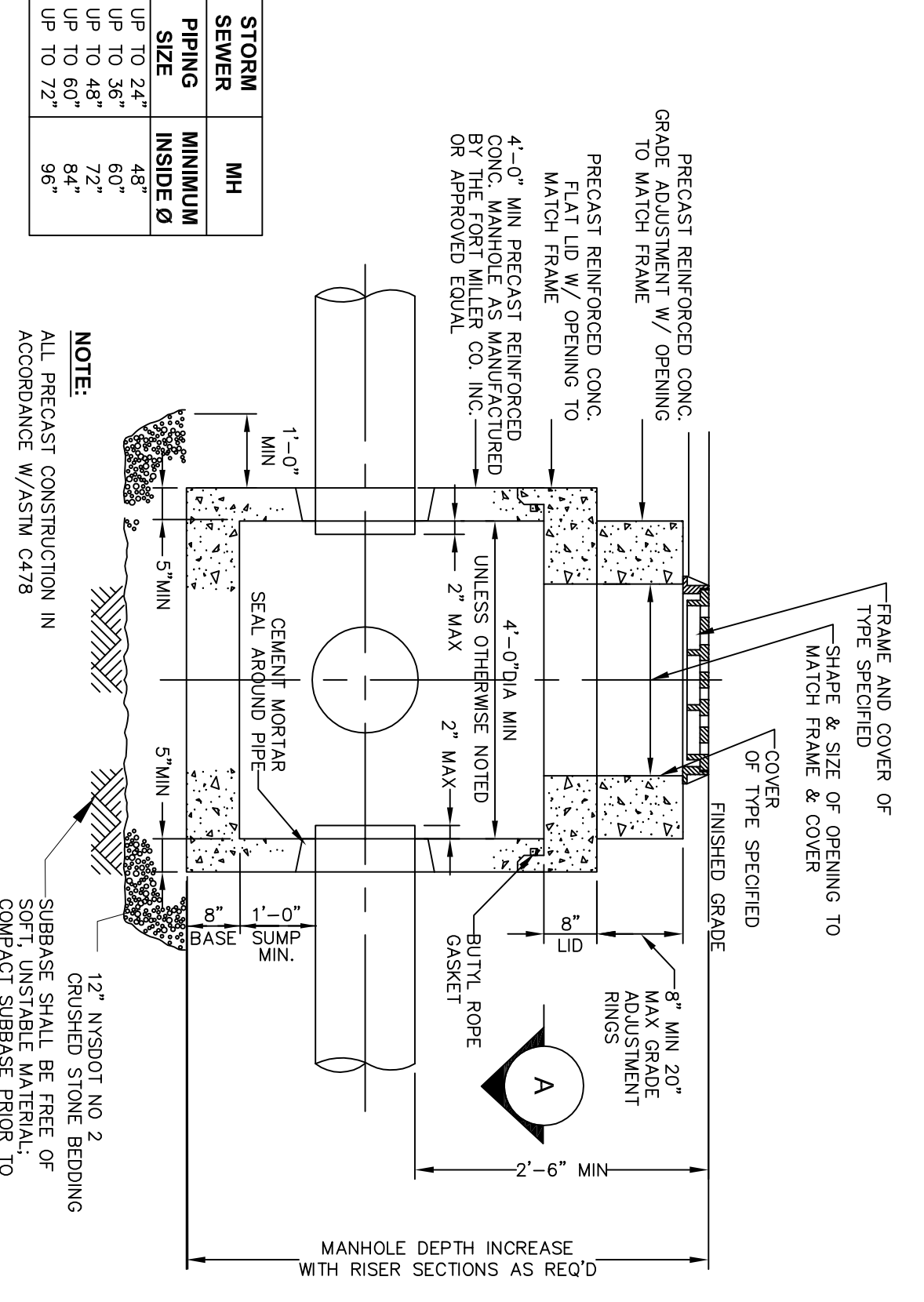

**PRECAST CONCRETE STORM SEWER
MANHOLE DETAIL**
NOT TO SCALE

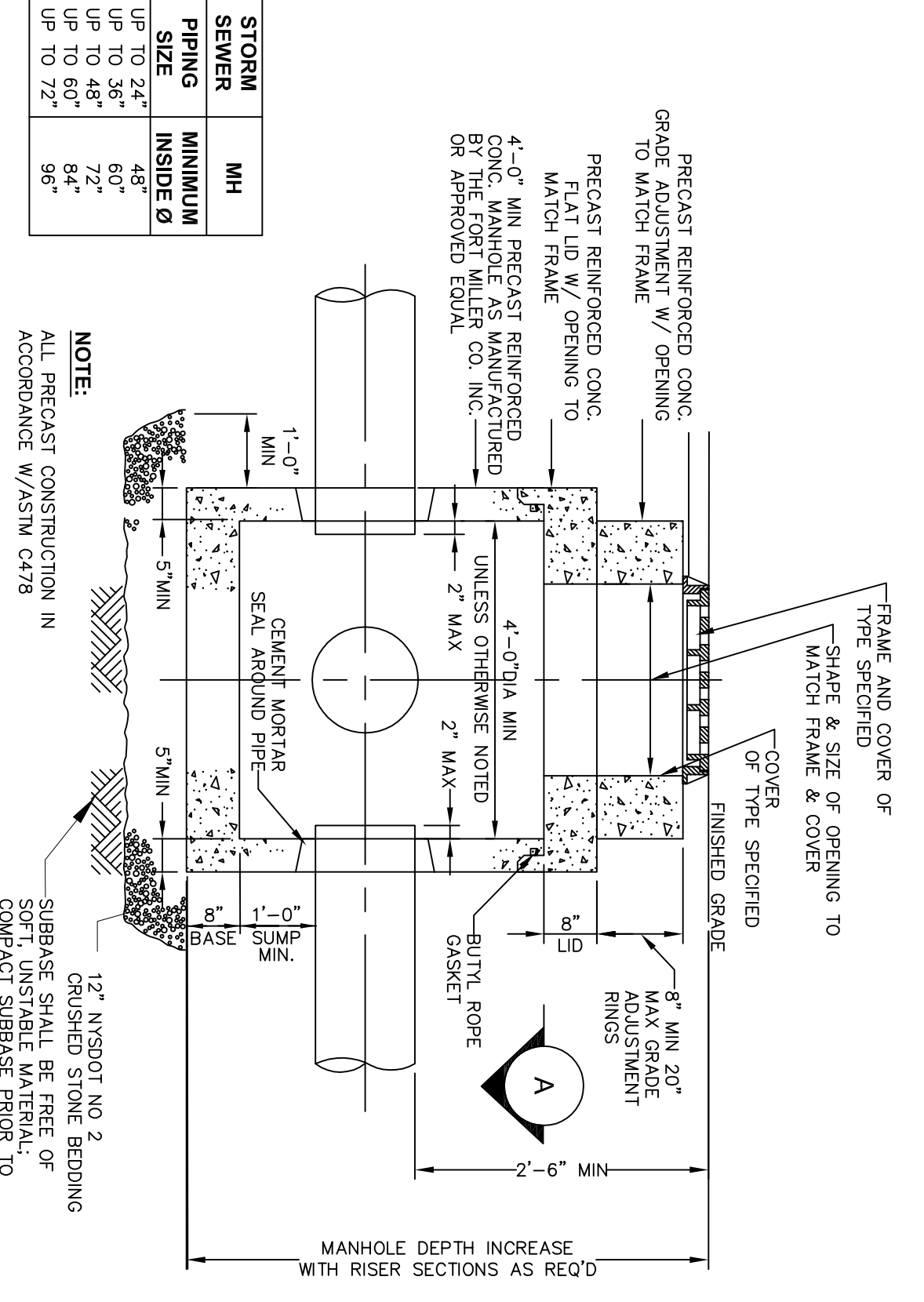

**PRECAST CONCRETE STORM SEWER
MANHOLE DETAIL**
NOT TO SCALE

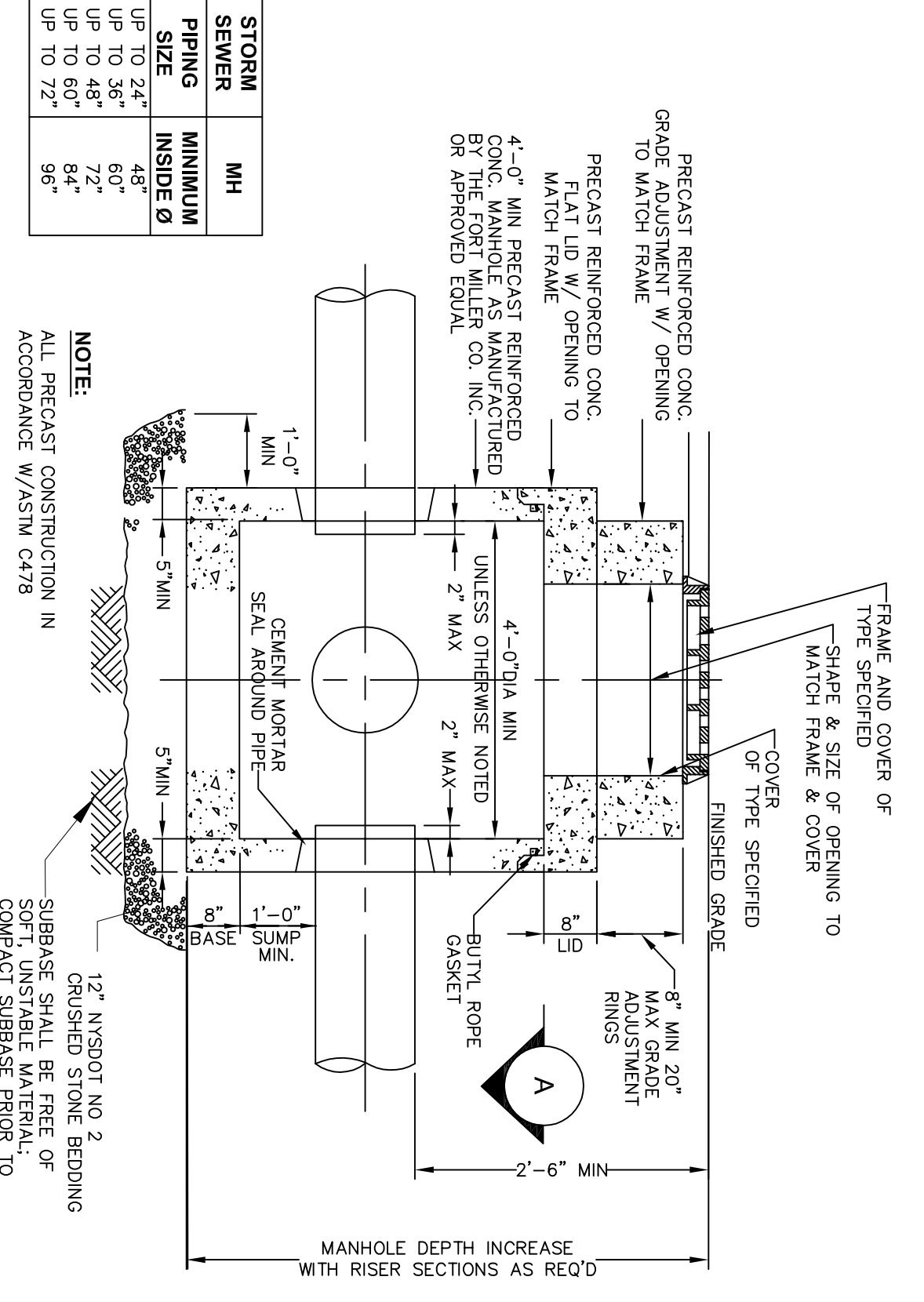

**PRECAST CONCRETE STORM SEWER
MANHOLE DETAIL**
NOT TO SCALE

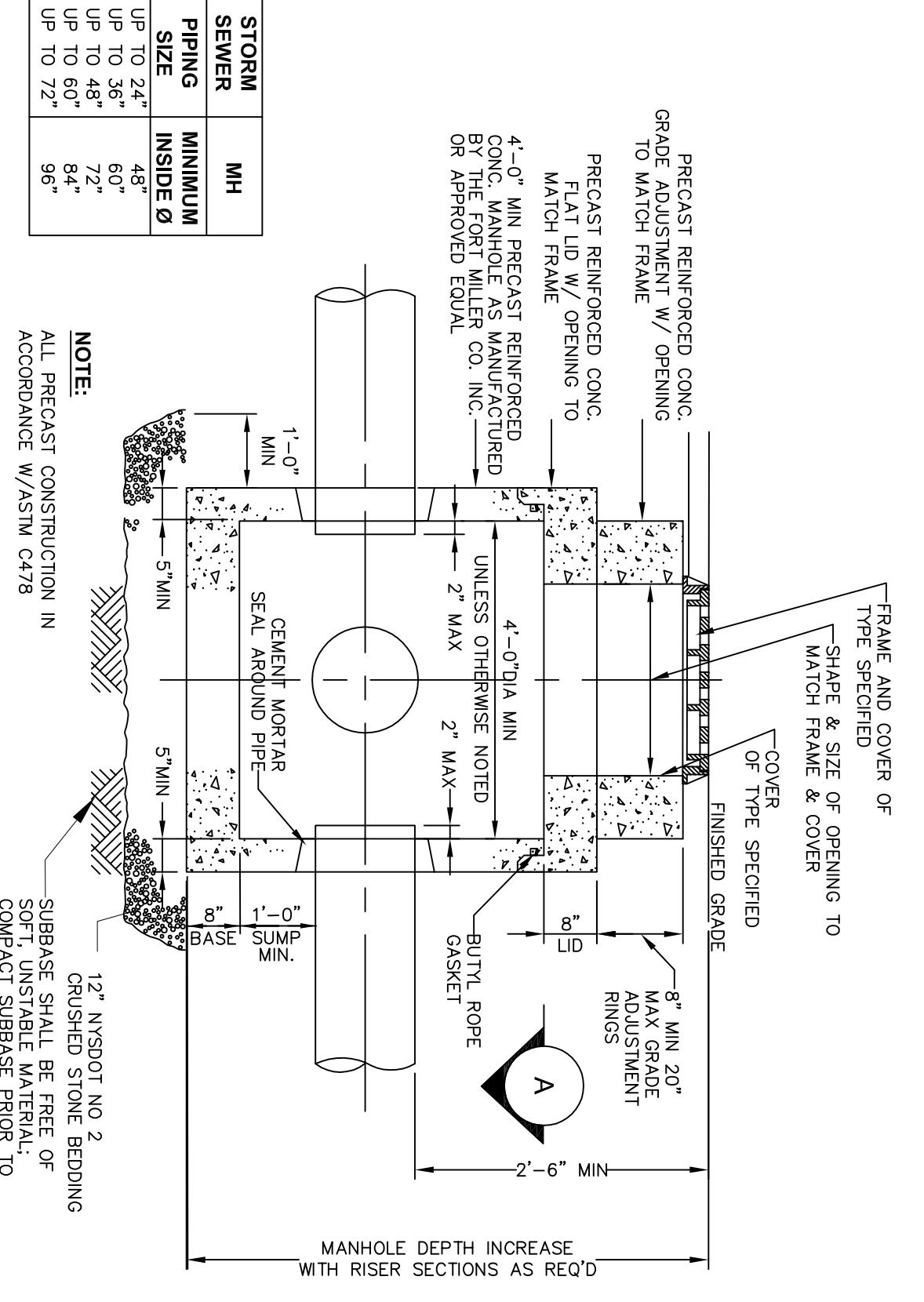

**PRECAST CONCRETE STORM SEWER
MANHOLE DETAIL**
NOT TO SCALE

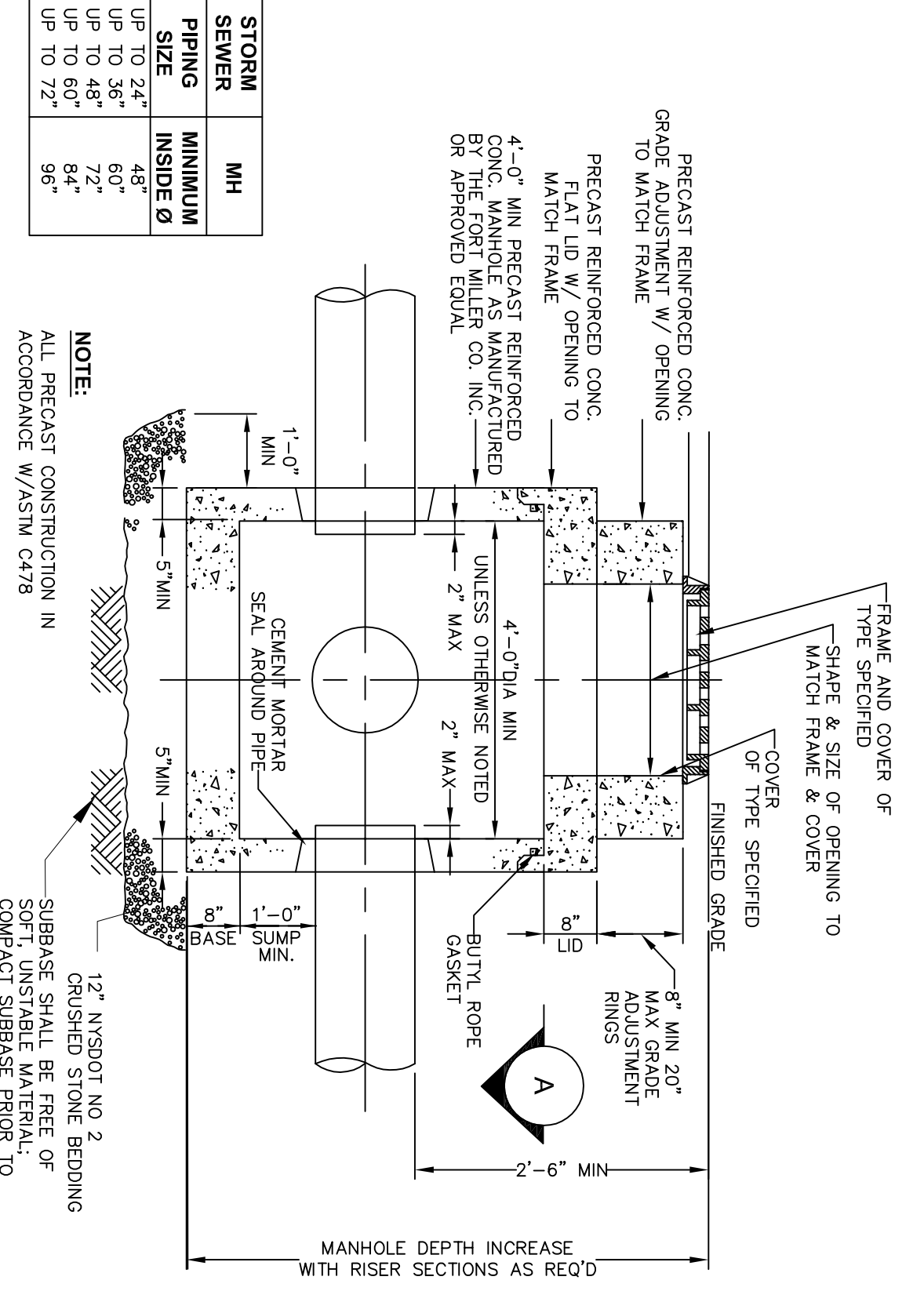

**PRECAST CONCRETE STORM SEWER
MANHOLE DETAIL**
NOT TO SCALE

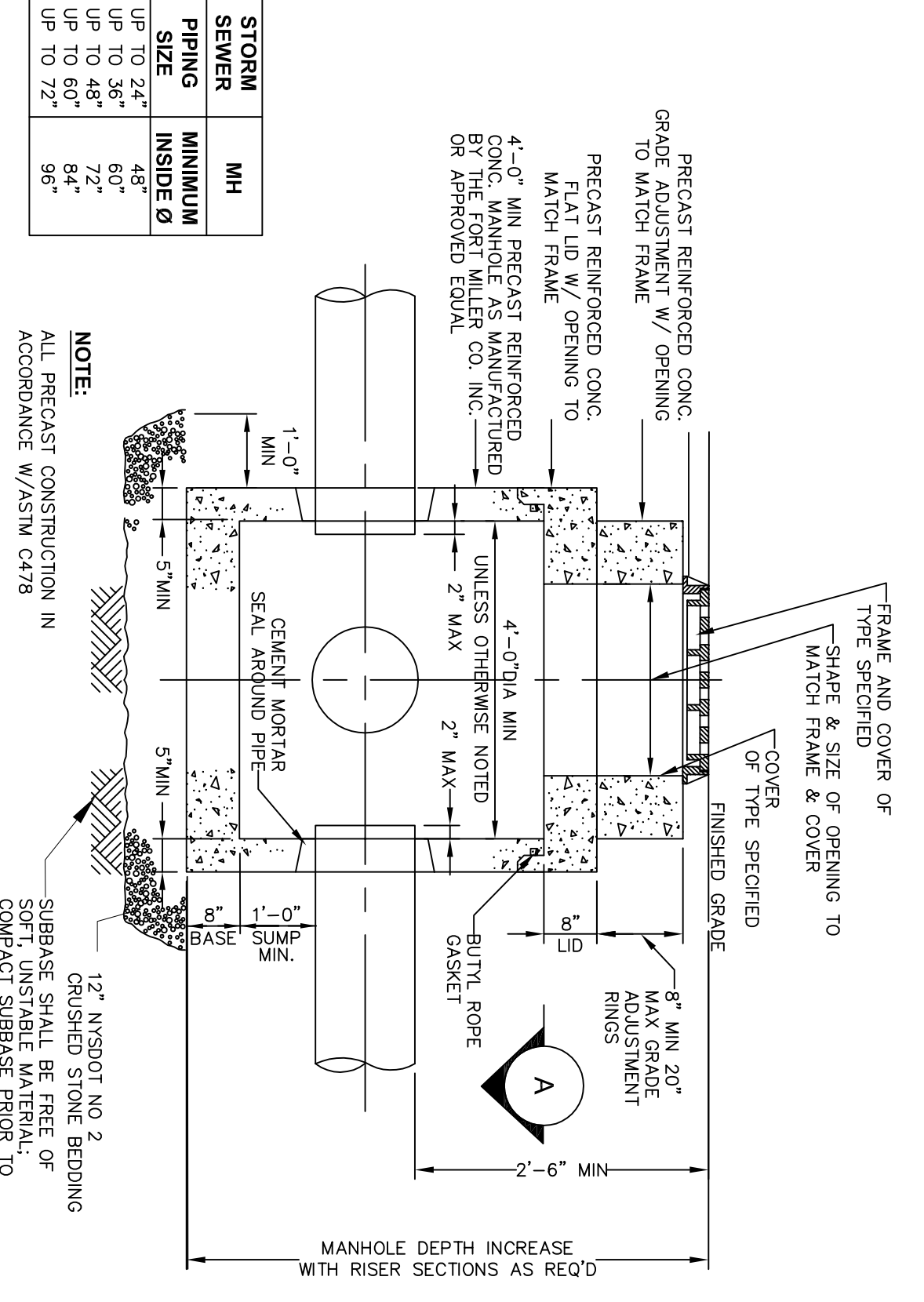

**PRECAST CONCRETE STORM SEWER
MANHOLE DETAIL**
NOT TO SCALE

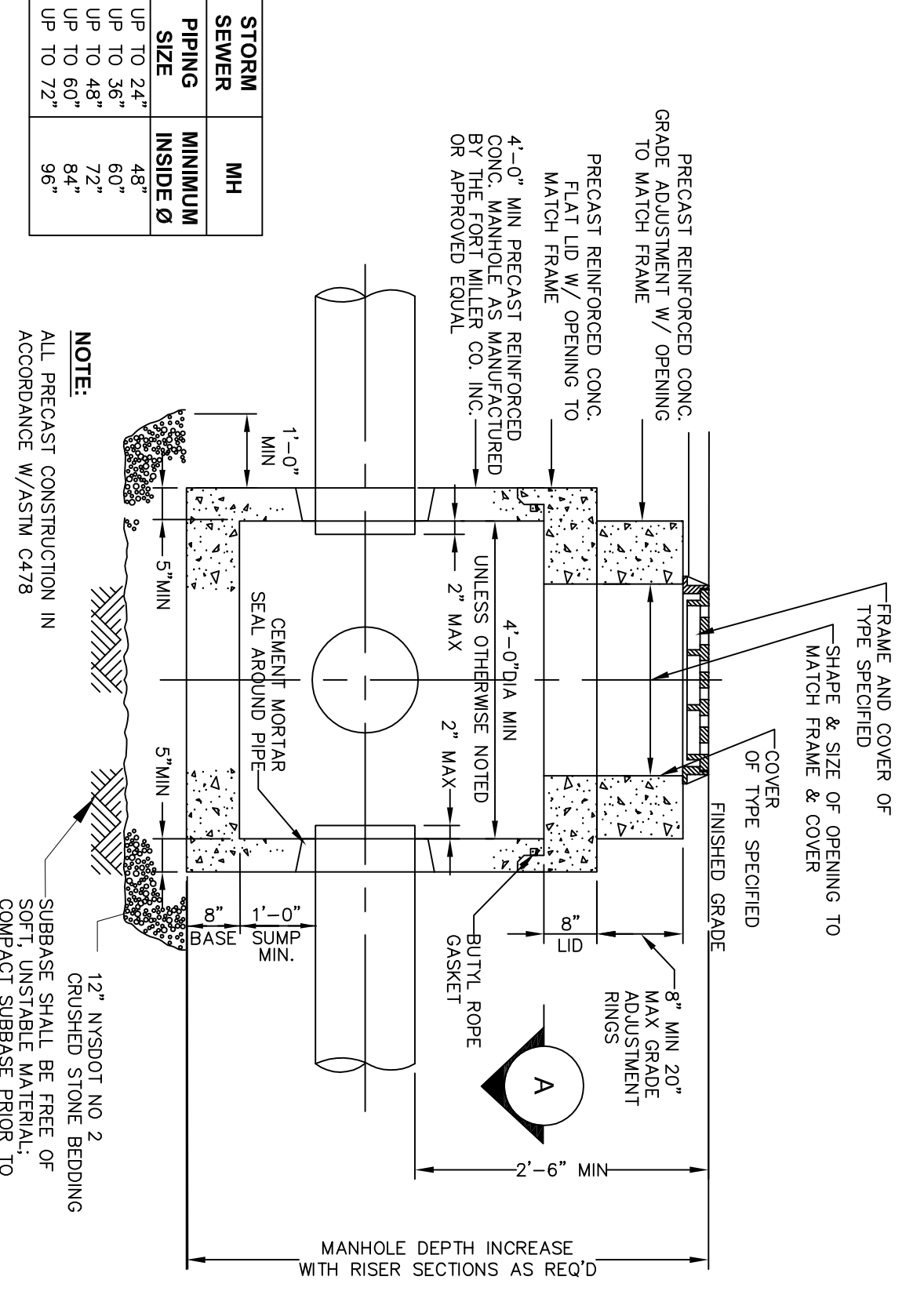

**PRECAST CONCRETE STORM SEWER
MANHOLE DETAIL**
NOT TO SCALE

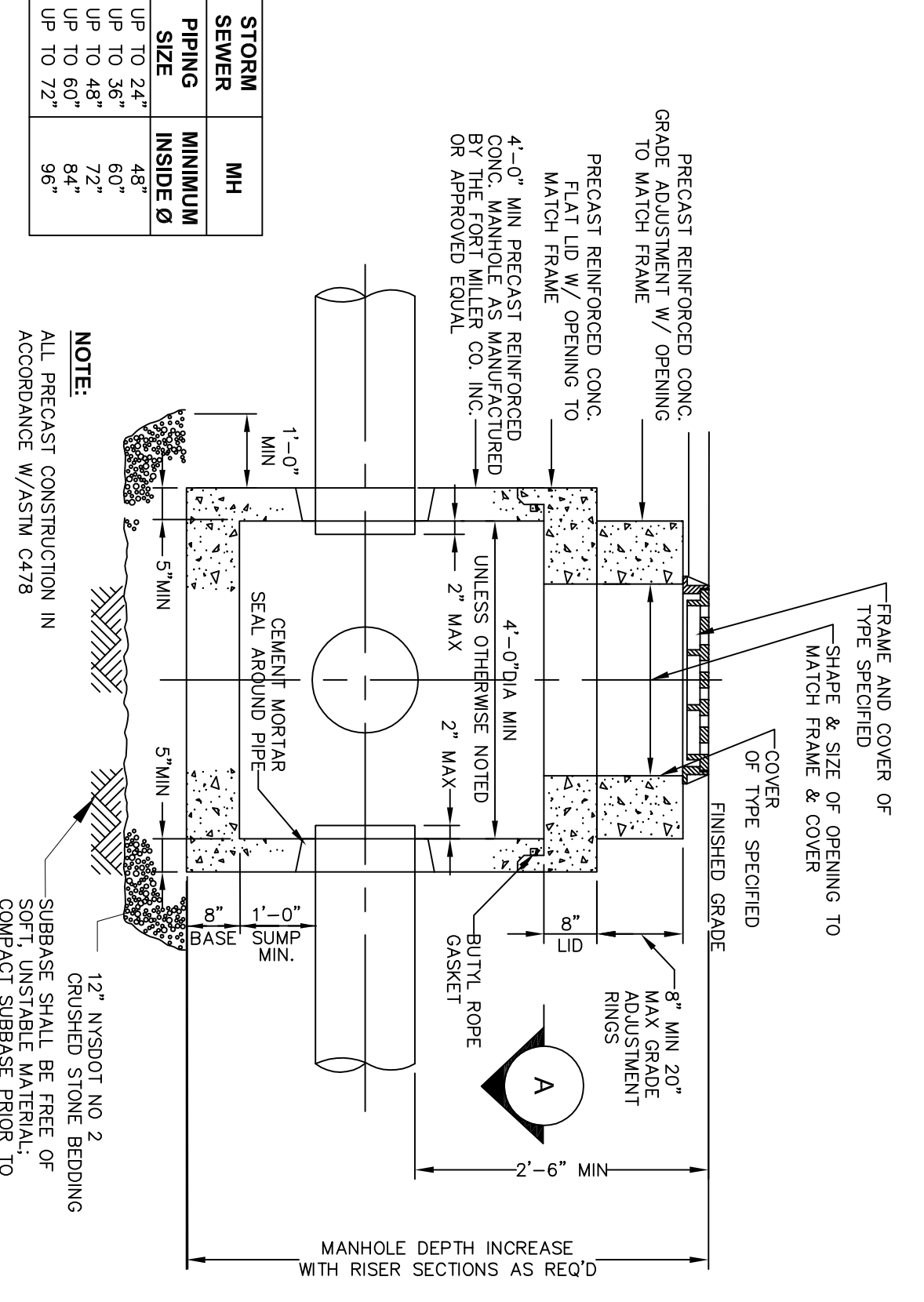

**PRECAST CONCRETE STORM SEWER
MANHOLE DETAIL**
NOT TO SCALE

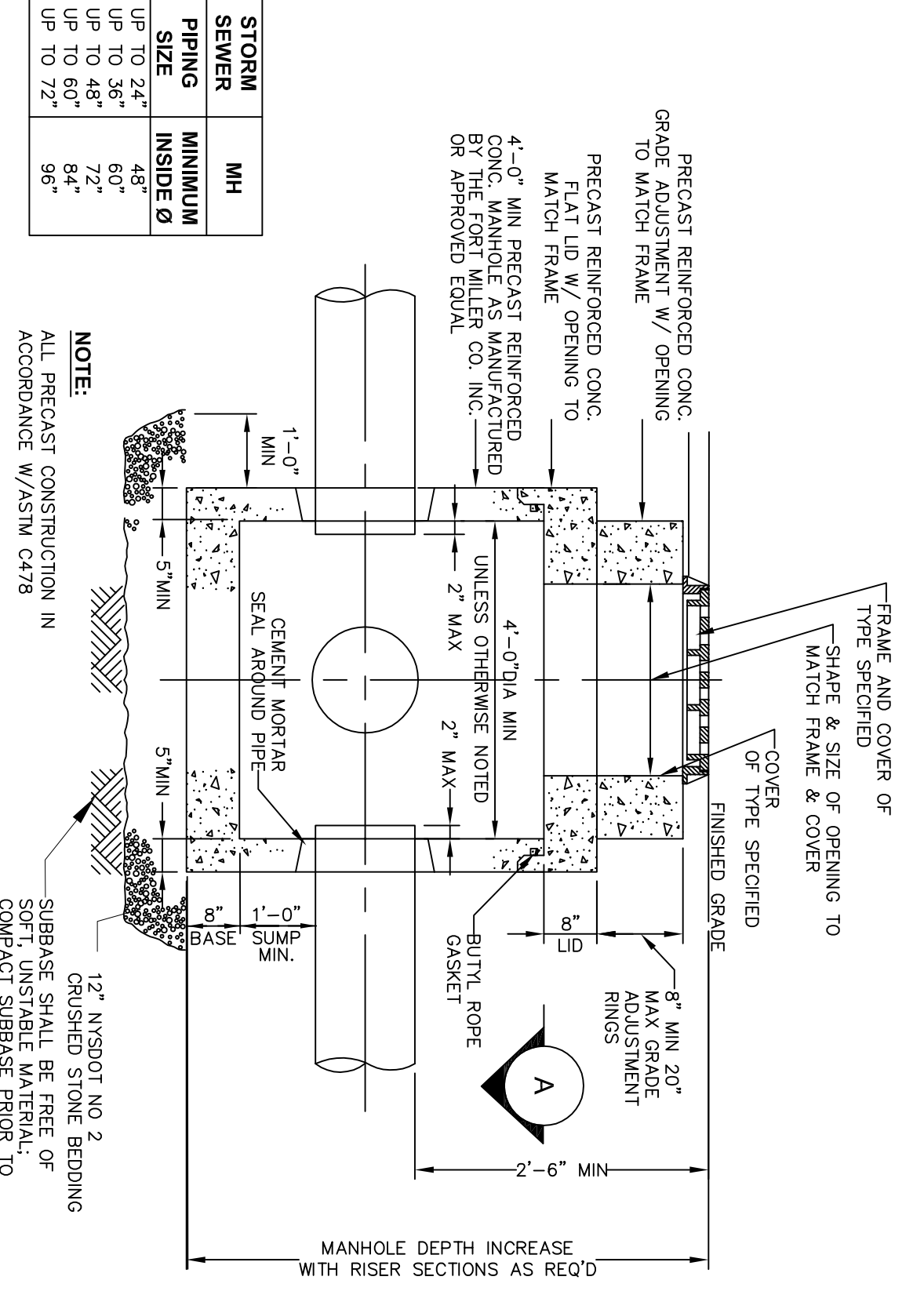

**PRECAST CONCRETE STORM SEWER
MANHOLE DETAIL**
NOT TO SCALE

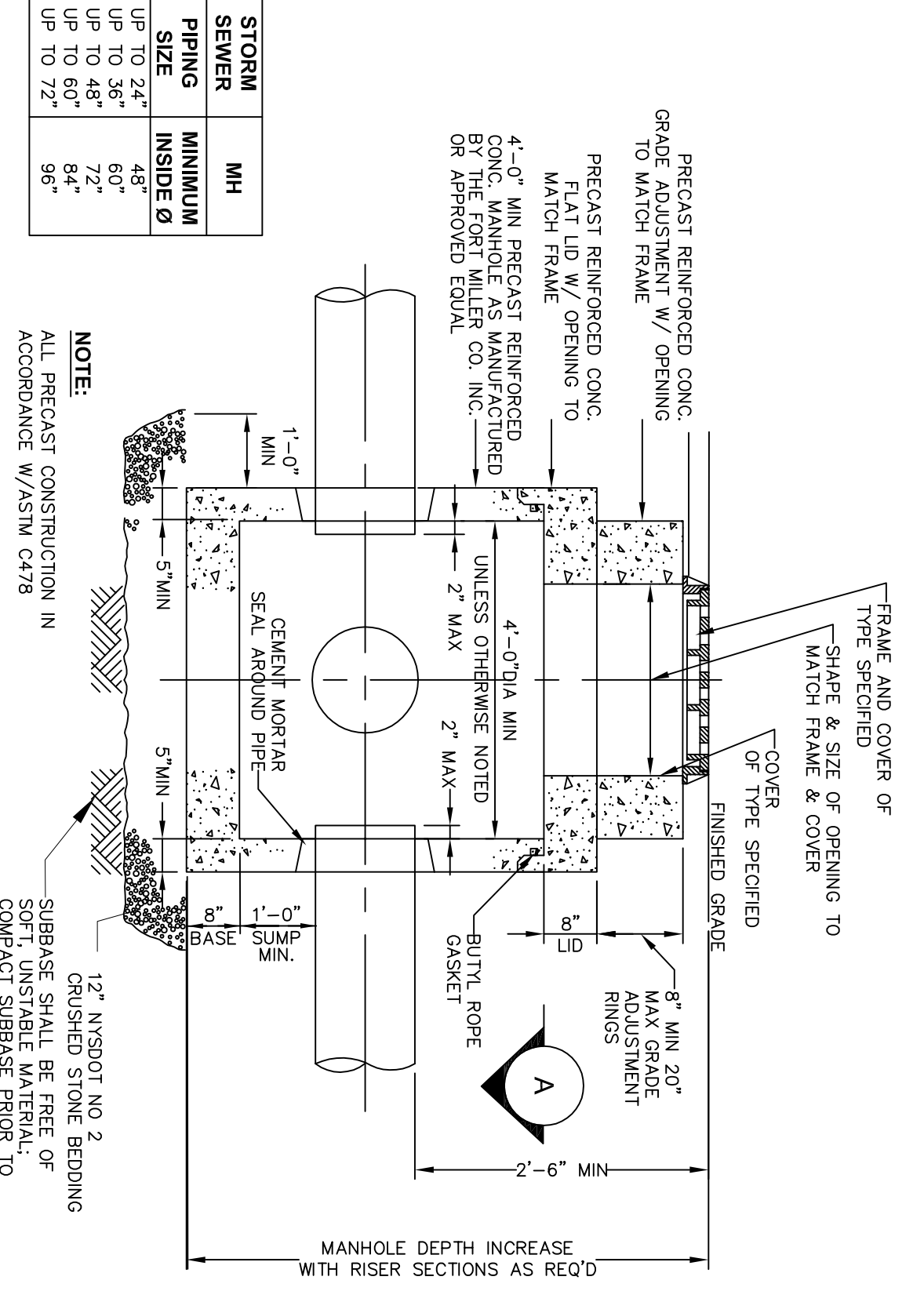

**PRECAST CONCRETE STORM SEWER
MANHOLE DETAIL**
NOT TO SCALE

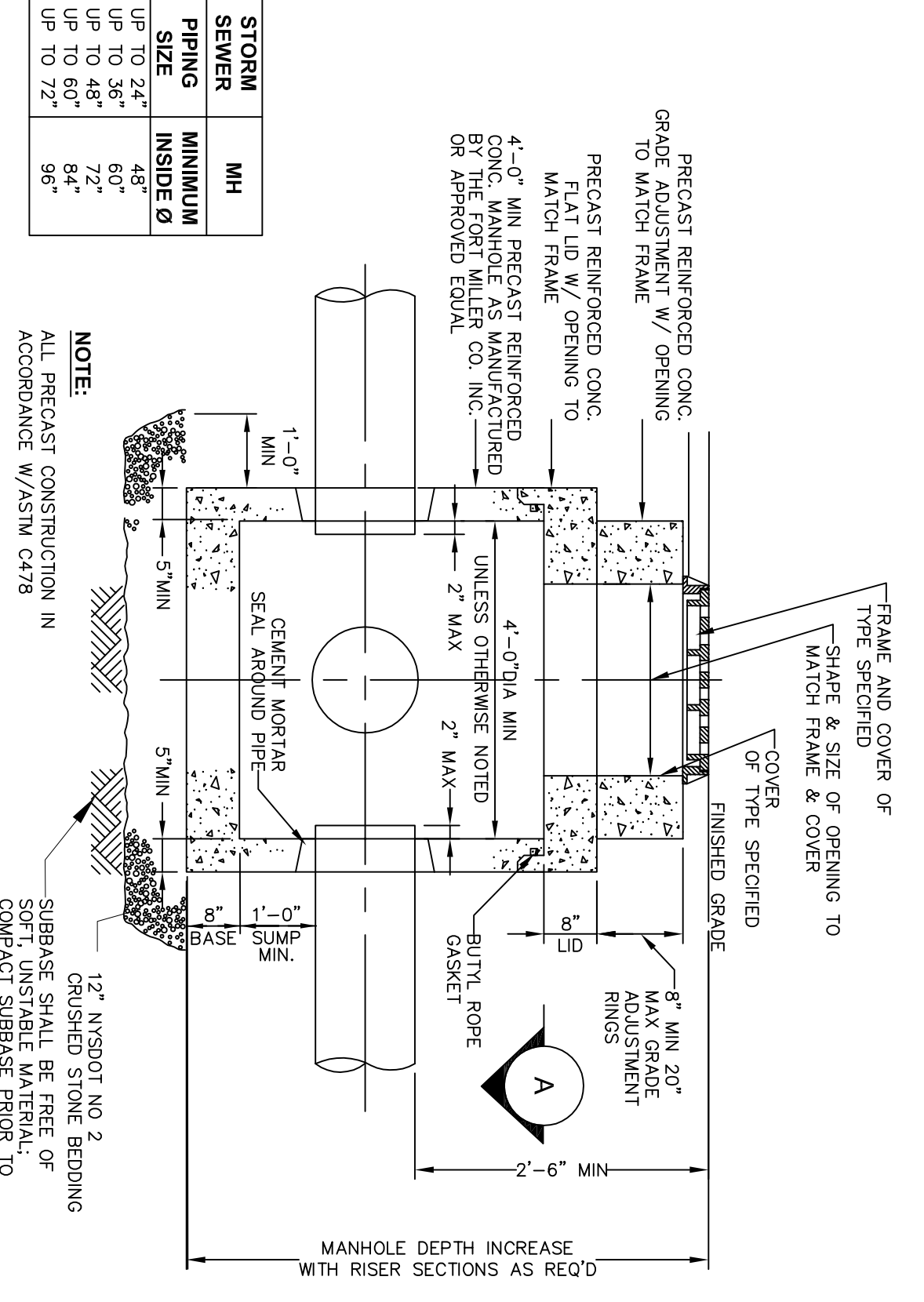

**PRECAST CONCRETE STORM SEWER
MANHOLE DETAIL**
NOT TO SCALE

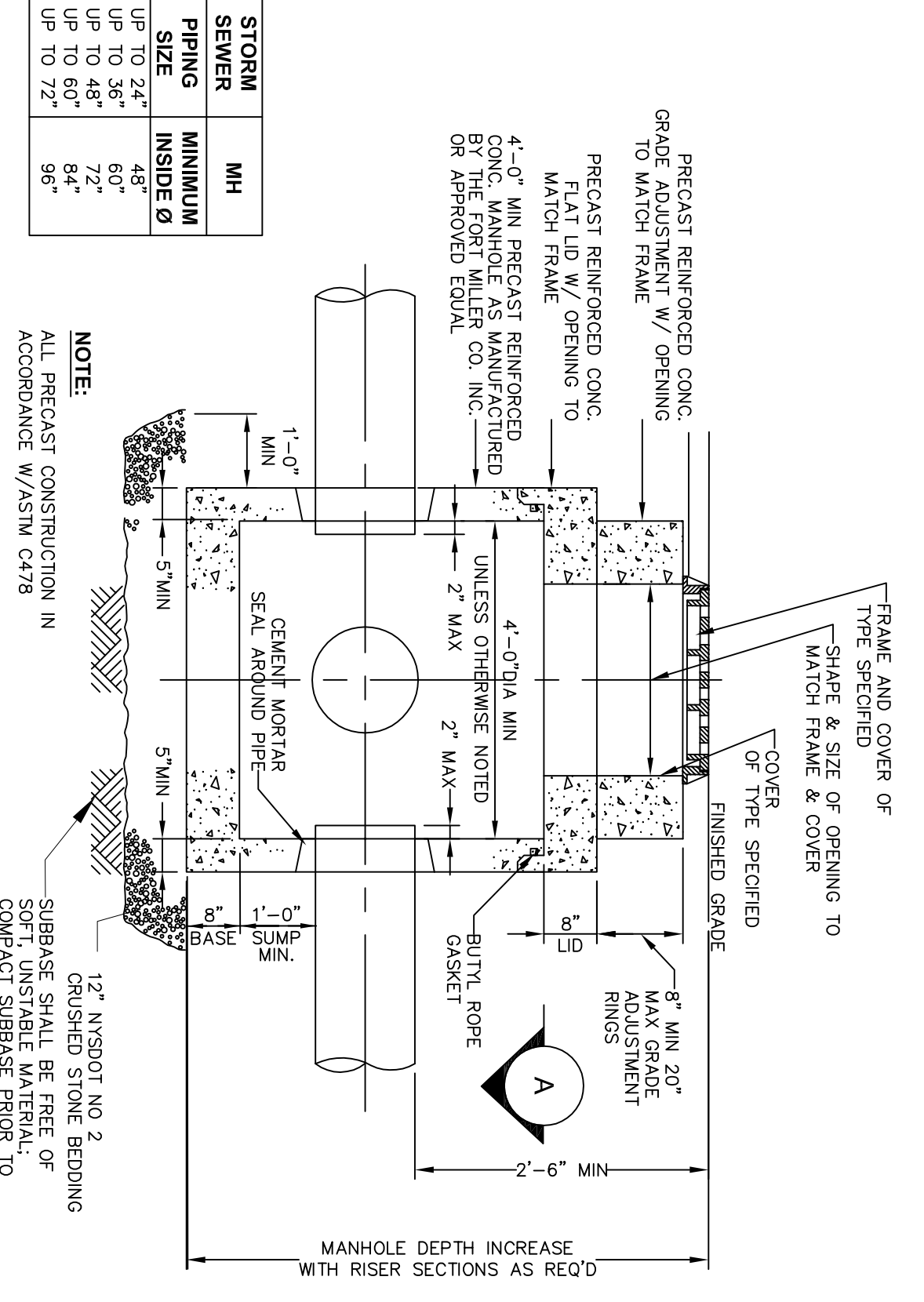

**PRECAST CONCRETE STORM SEWER
MANHOLE DETAIL**
NOT TO SCALE

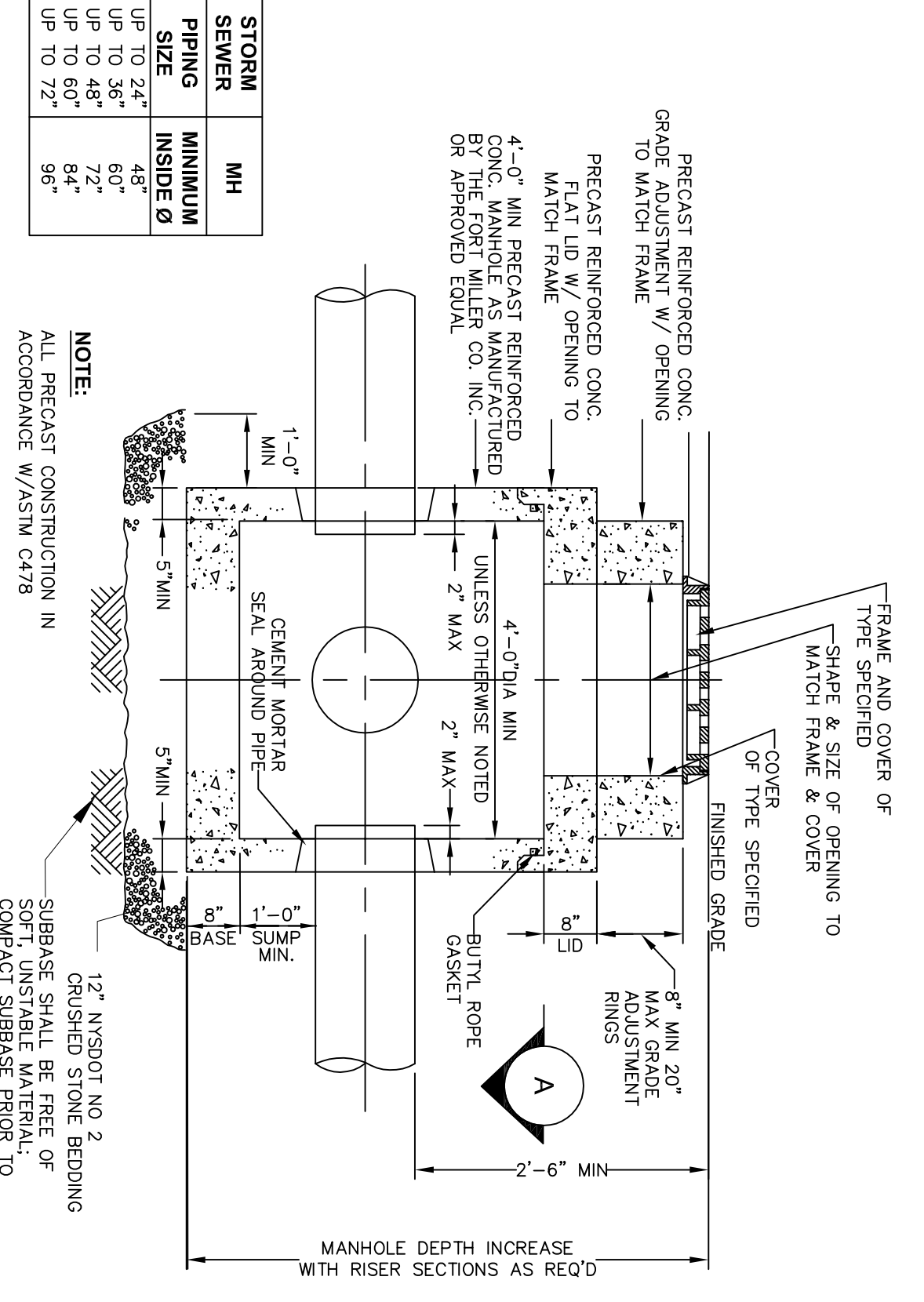

**PRECAST CONCRETE STORM SEWER
MANHOLE DETAIL**
NOT TO SCALE

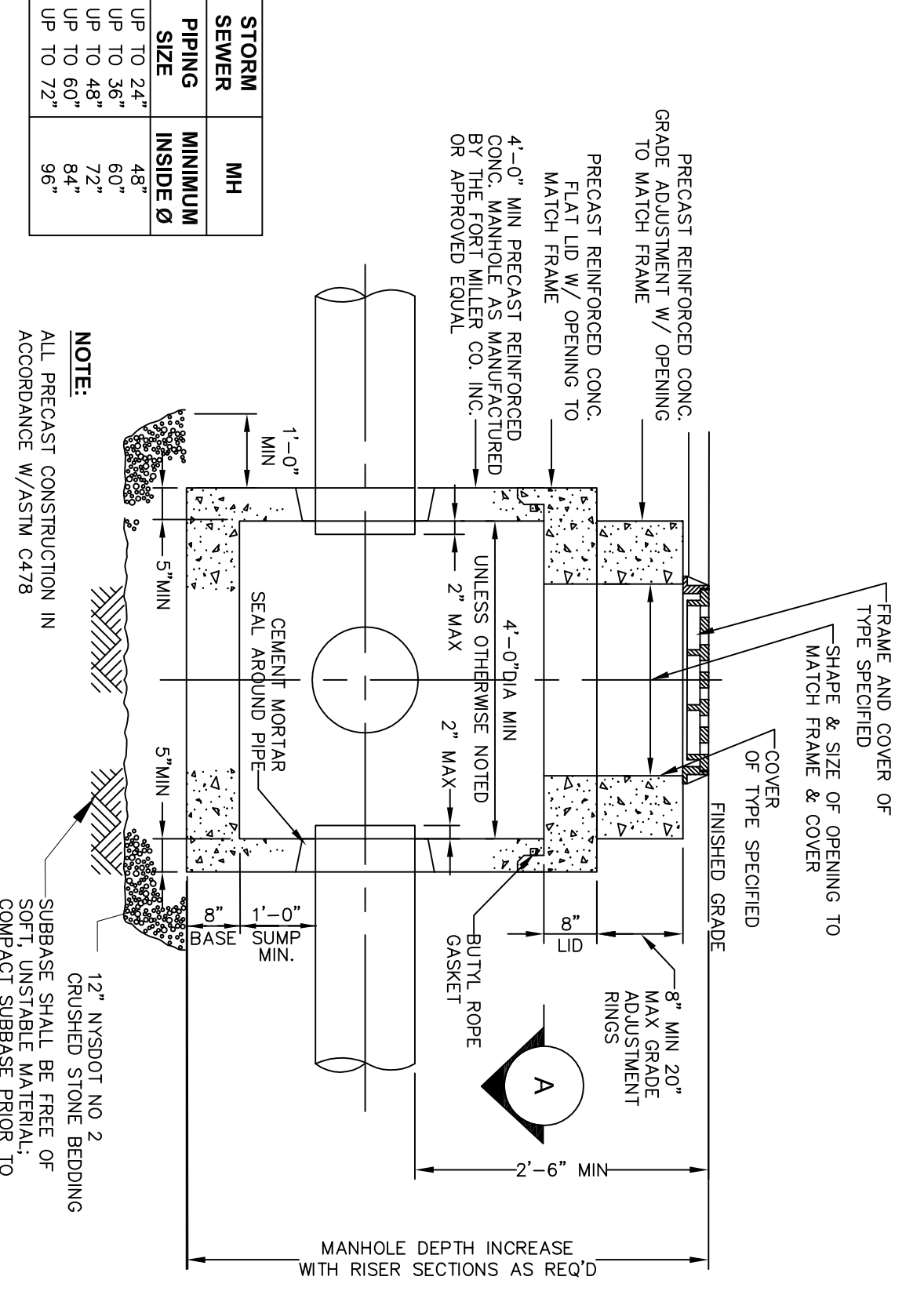

**PRECAST CONCRETE STORM SEWER
MANHOLE DETAIL**
NOT TO SCALE

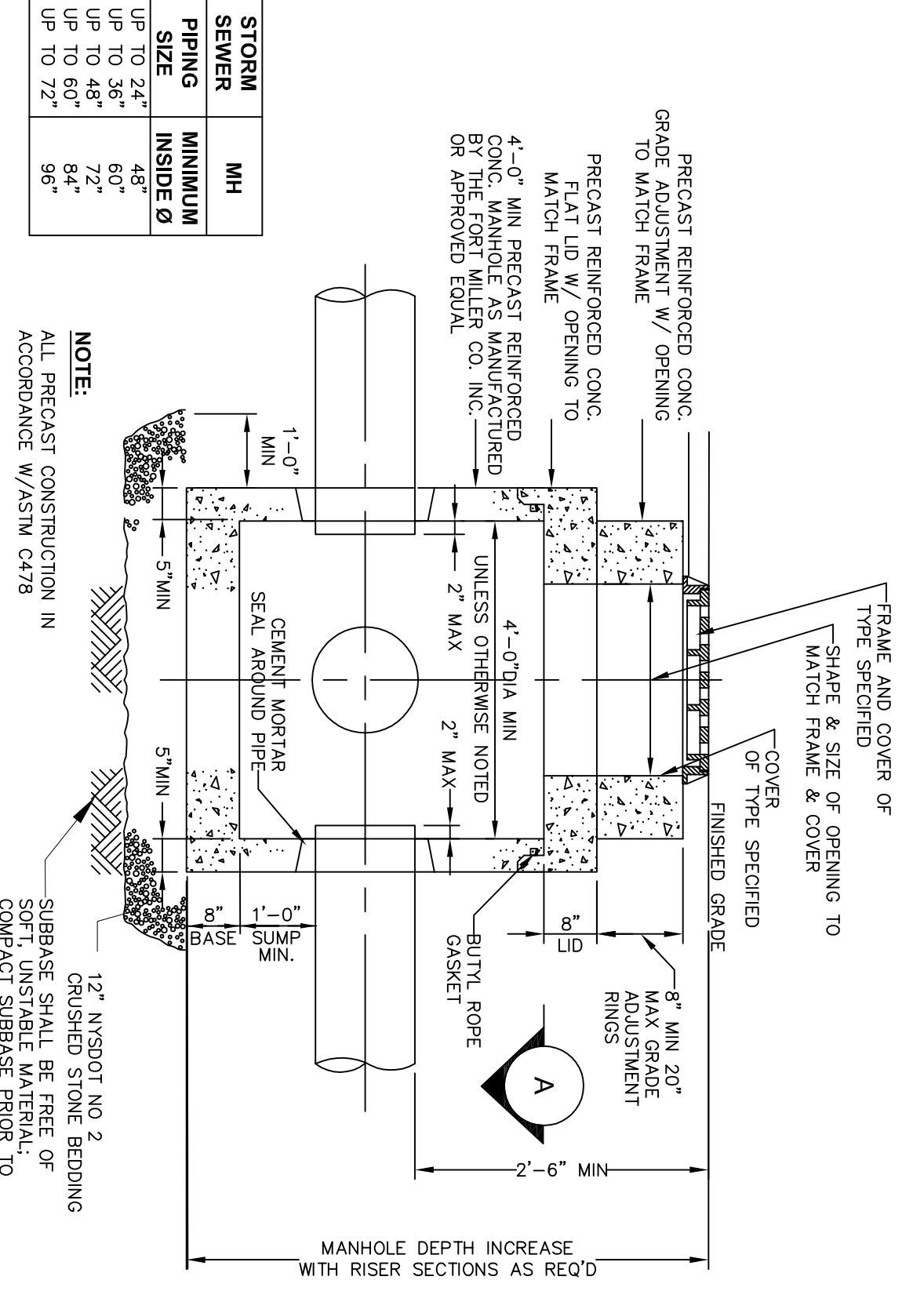

**PRECAST CONCRETE STORM SEWER
MANHOLE DETAIL**
NOT TO SCALE

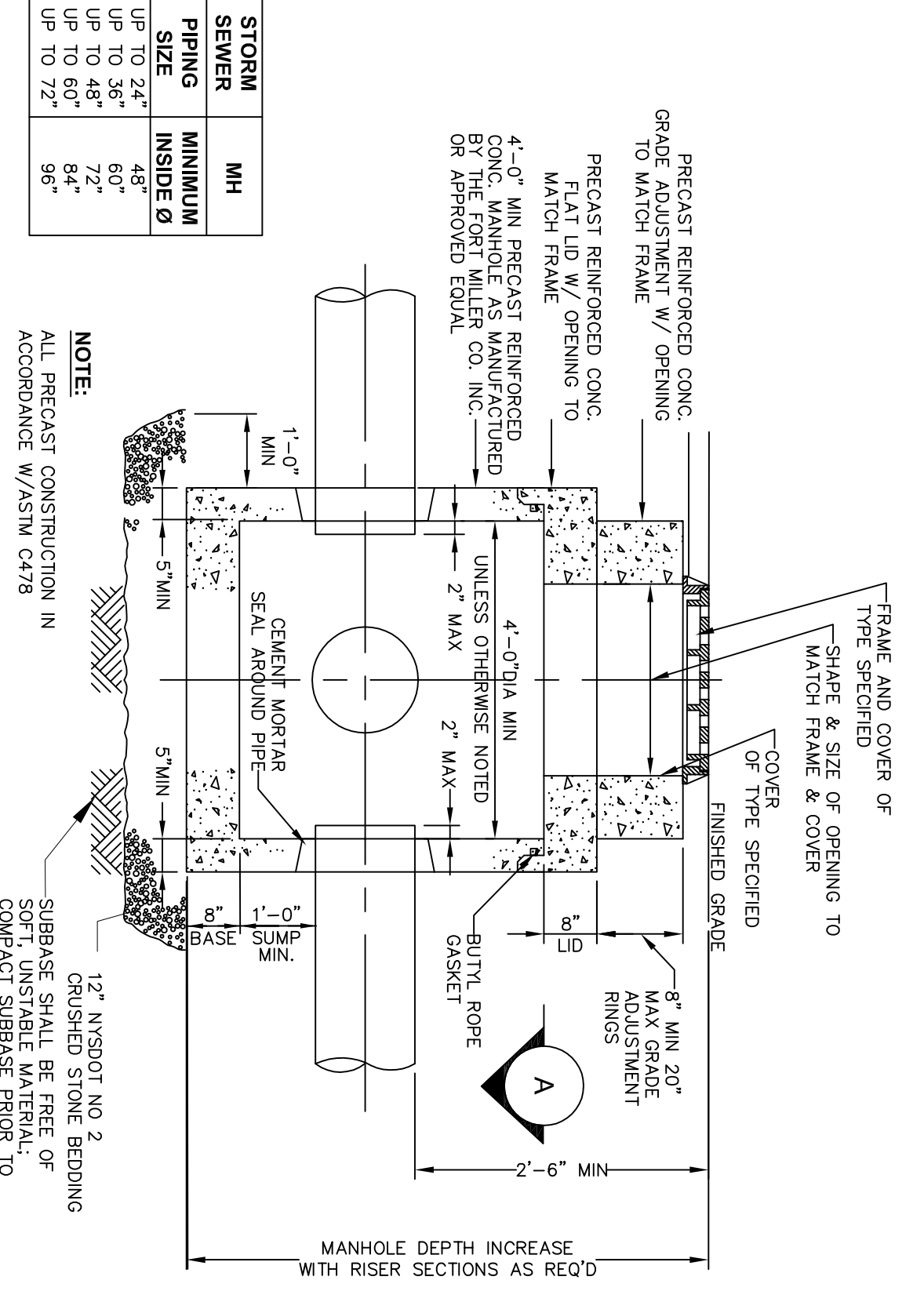

**PRECAST CONCRETE STORM SEWER
MANHOLE DETAIL**
NOT TO SCALE

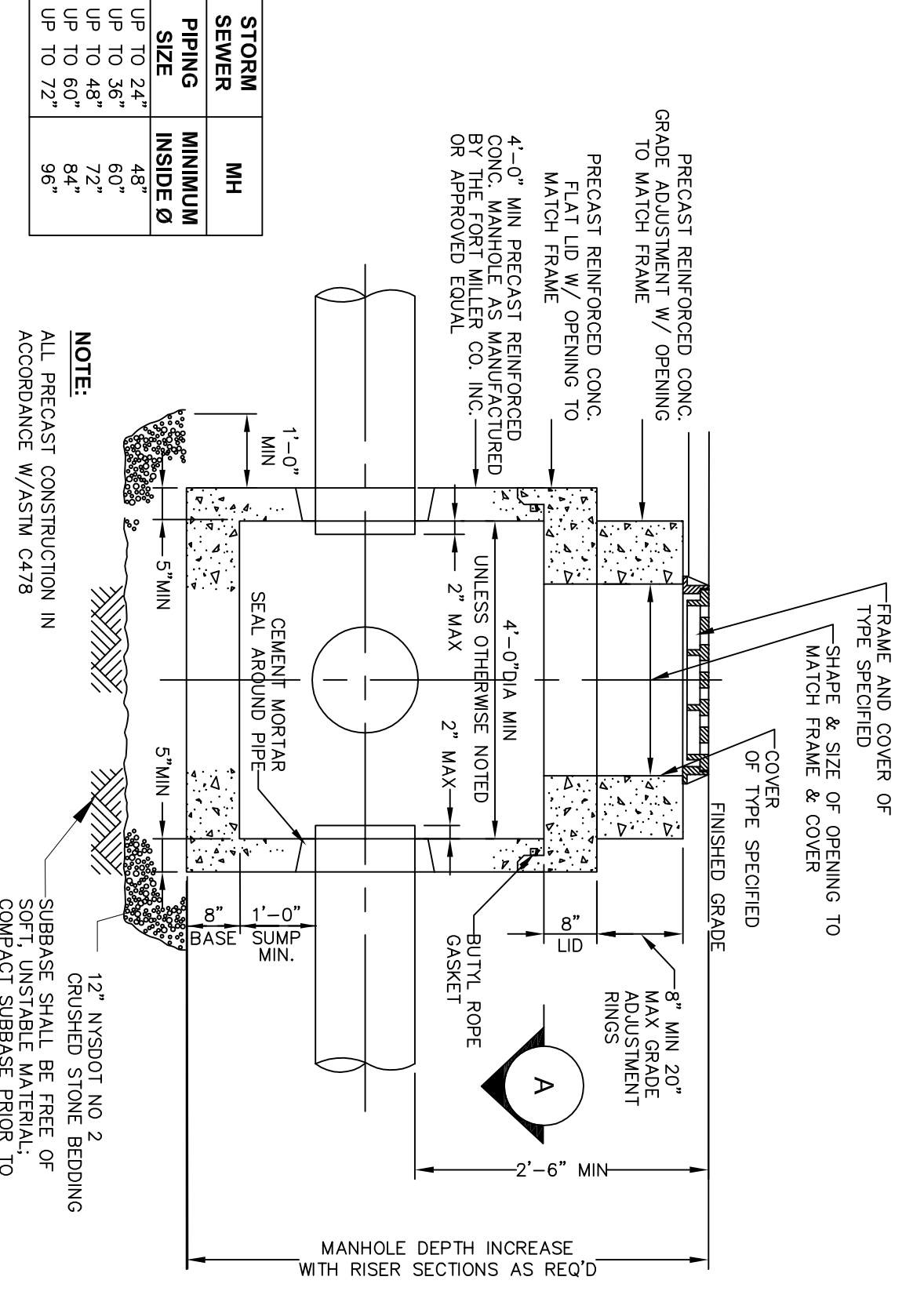

**PRECAST CONCRETE STORM SEWER
MANHOLE DETAIL**
NOT TO SCALE

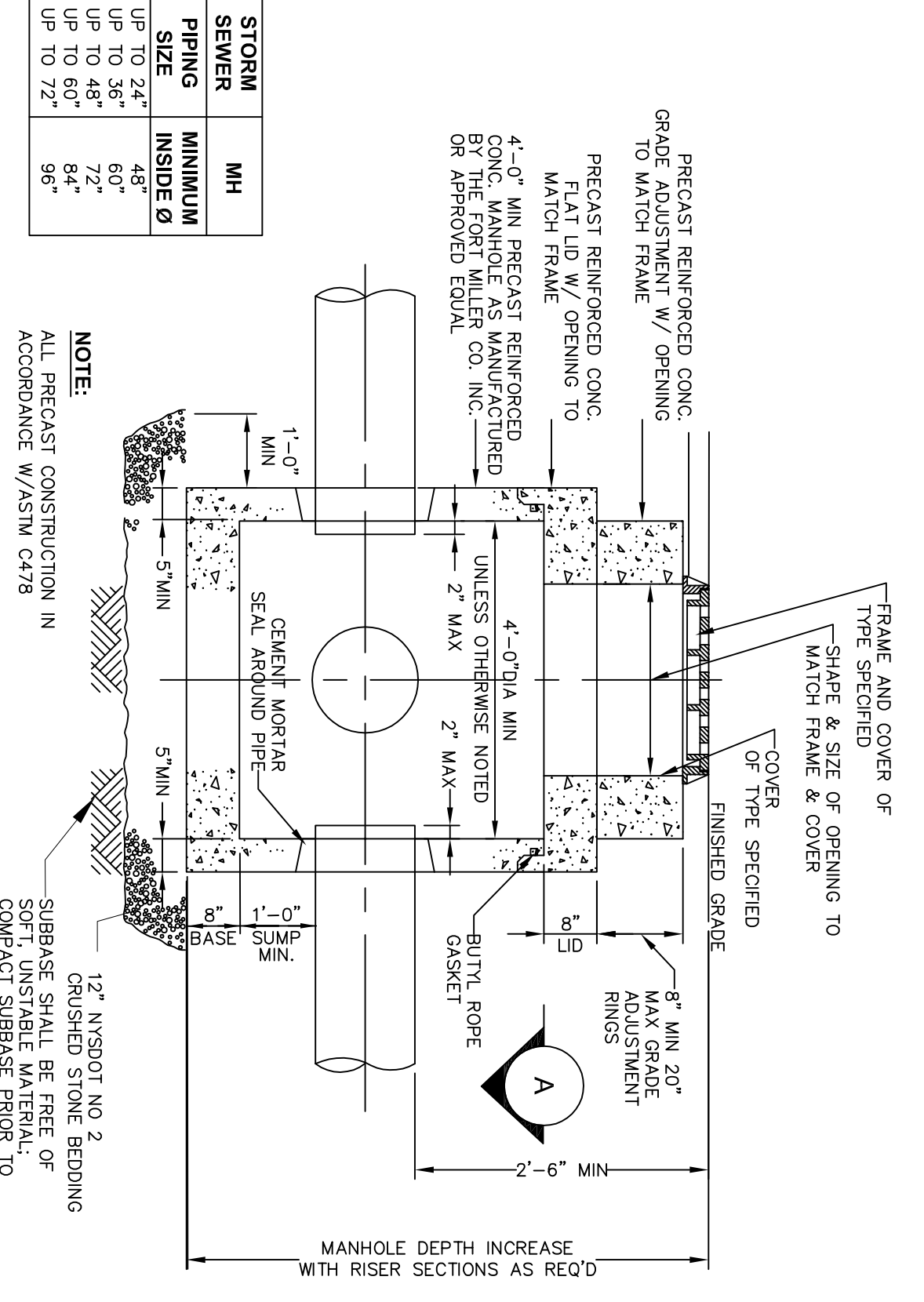

**PRECAST CONCRETE STORM SEWER
MANHOLE DETAIL**
NOT TO SCALE

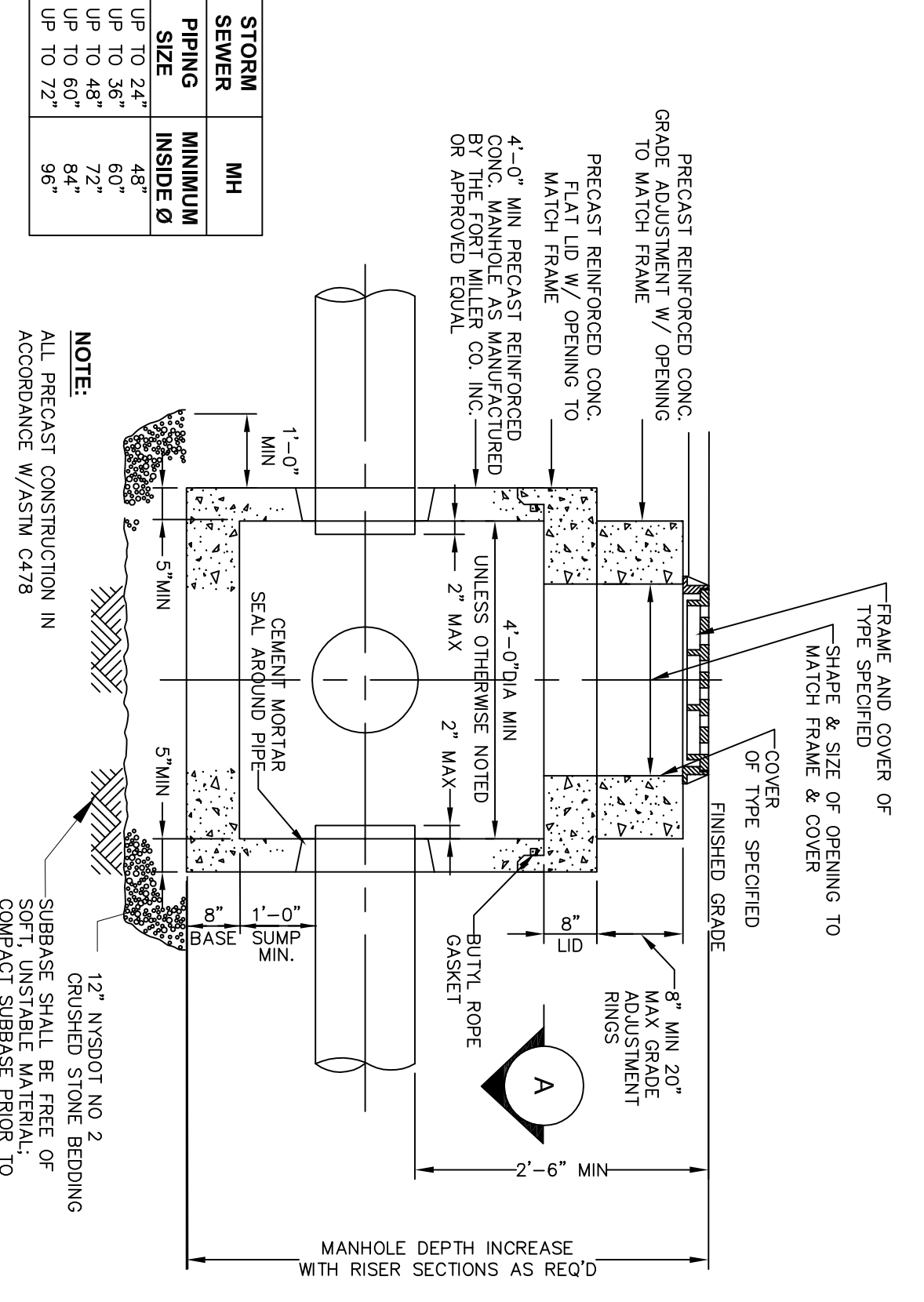

**PRECAST CONCRETE STORM SEWER
MANHOLE DETAIL**
NOT TO SCALE

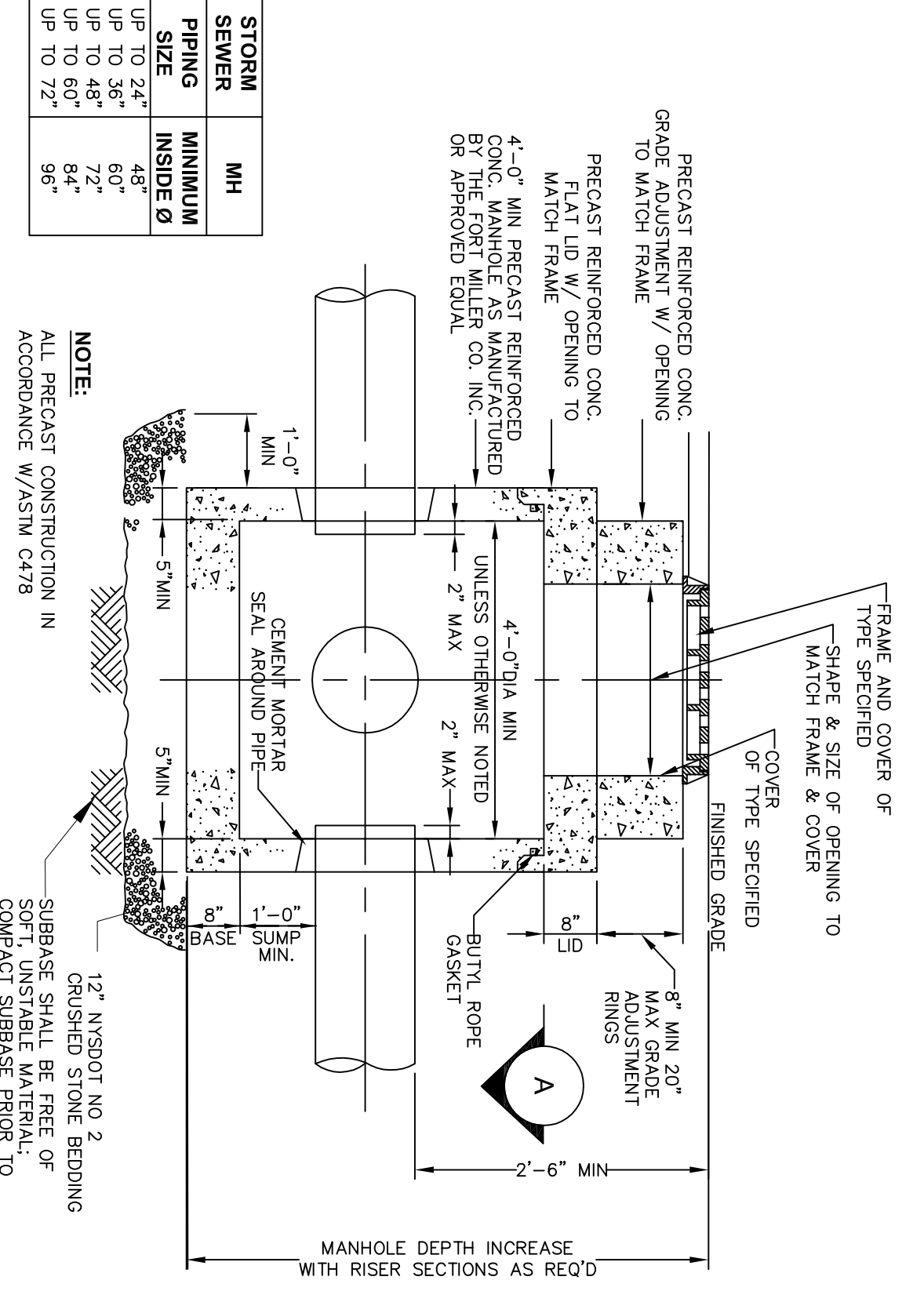

**PRECAST CONCRETE STORM SEWER
MANHOLE DETAIL**
NOT TO SCALE

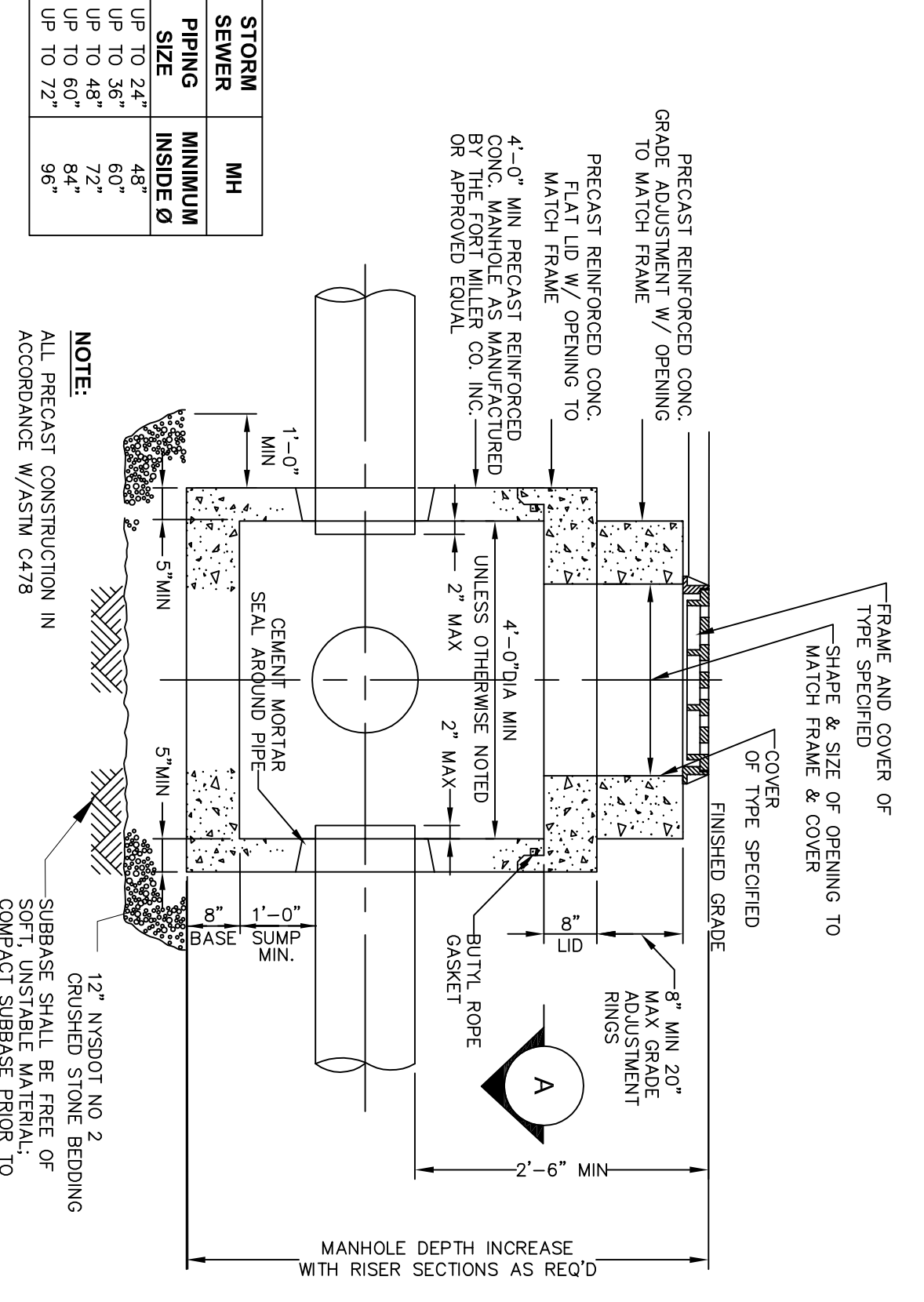

**PRECAST CONCRETE STORM SEWER
MANHOLE DETAIL**
NOT TO SCALE

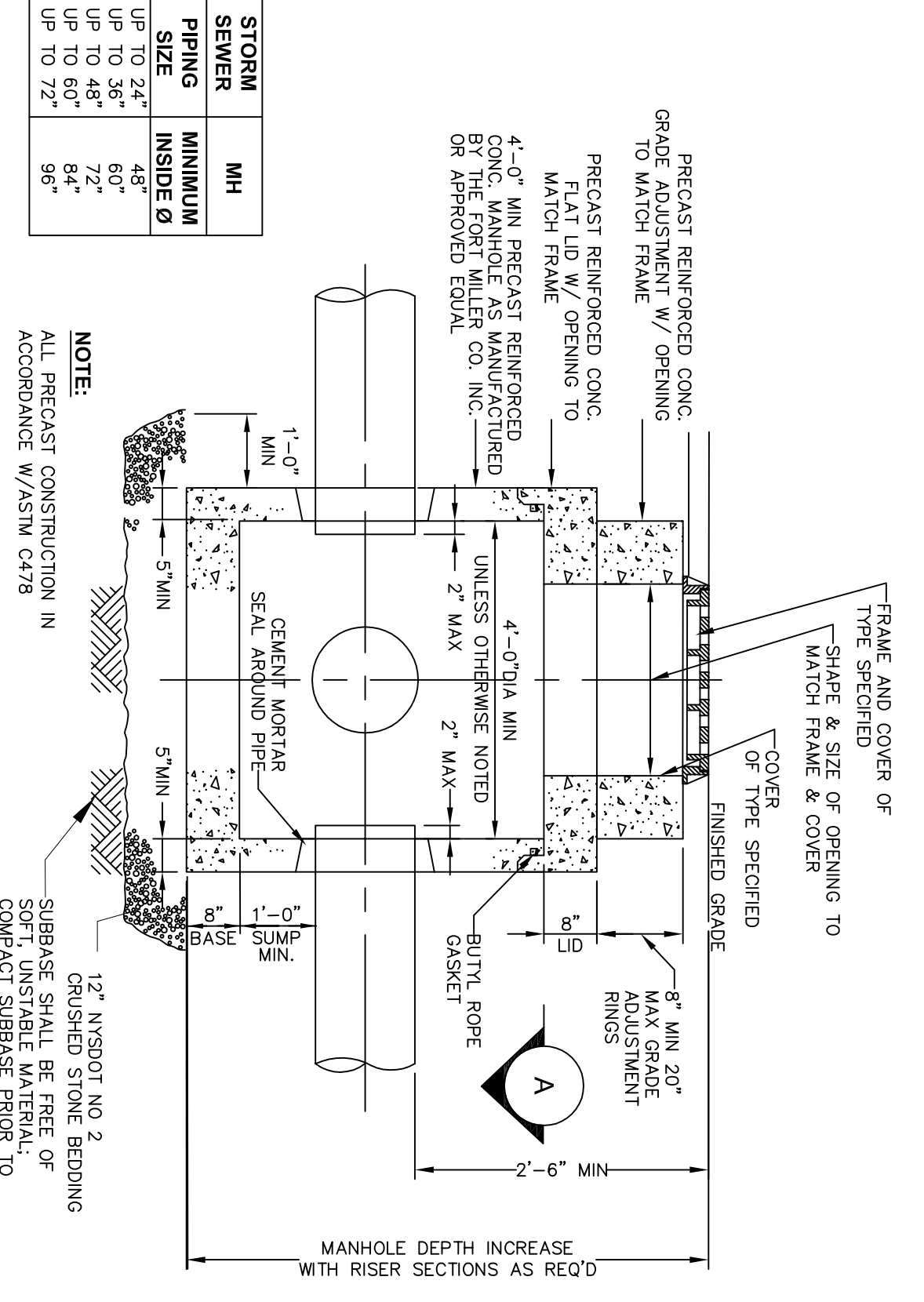

**PRECAST CONCRETE STORM SEWER
MANHOLE DETAIL**
NOT TO SCALE

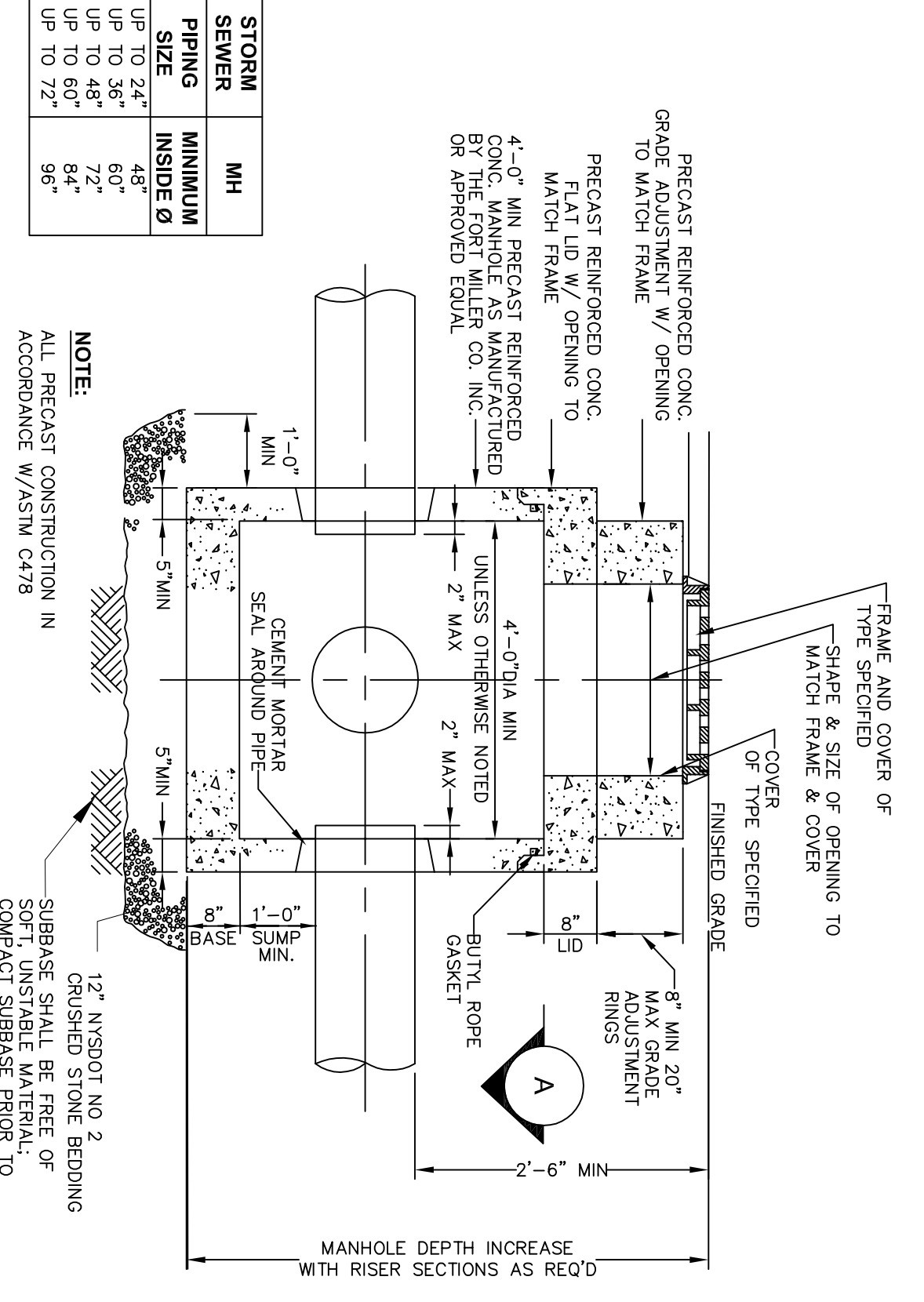

**PRECAST CONCRETE STORM SEWER
MANHOLE DETAIL**
NOT TO SCALE

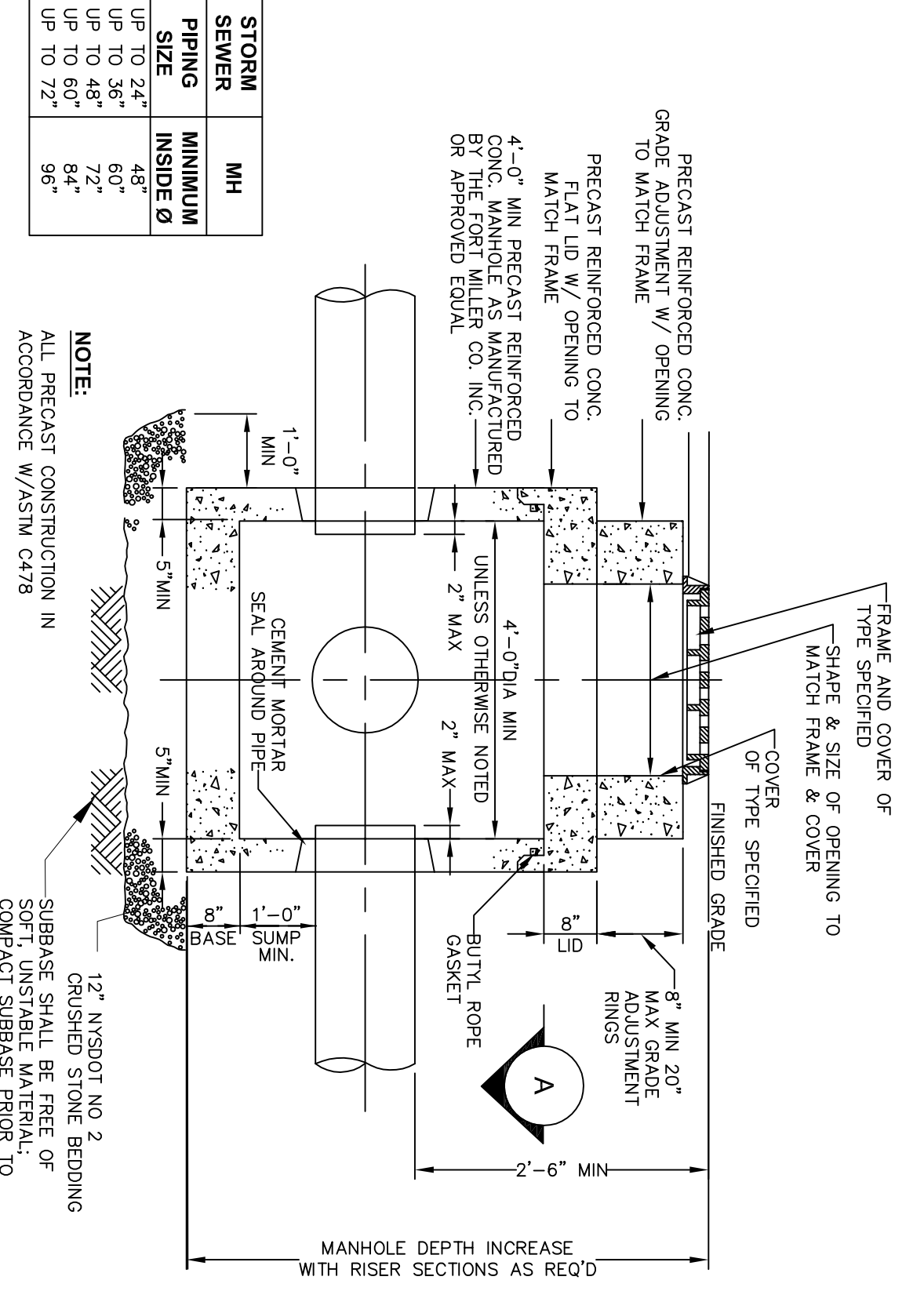

**PRECAST CONCRETE STORM SEWER
MANHOLE DETAIL**
NOT TO SCALE

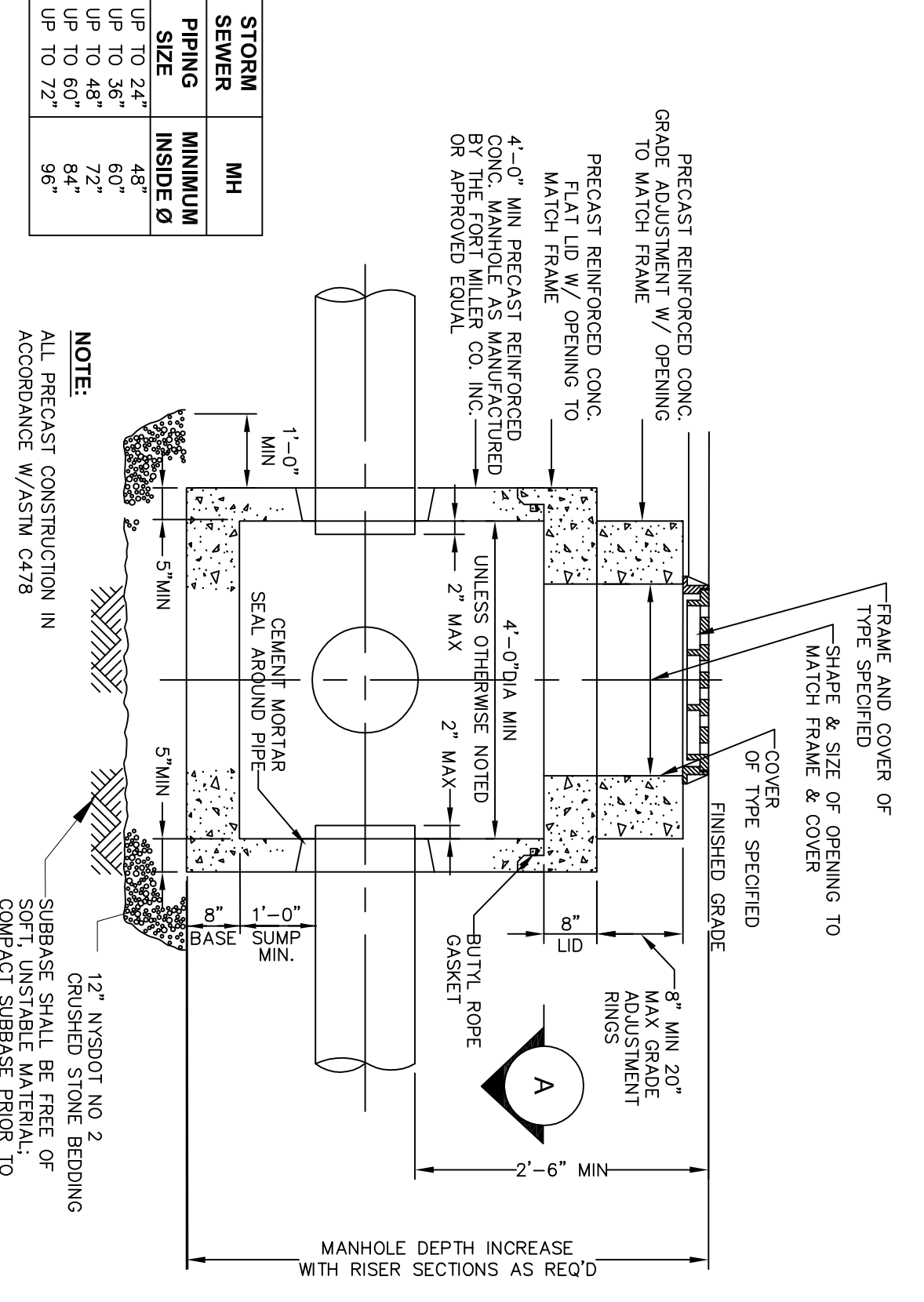

**PRECAST CONCRETE STORM SEWER
MANHOLE DETAIL**
NOT TO SCALE

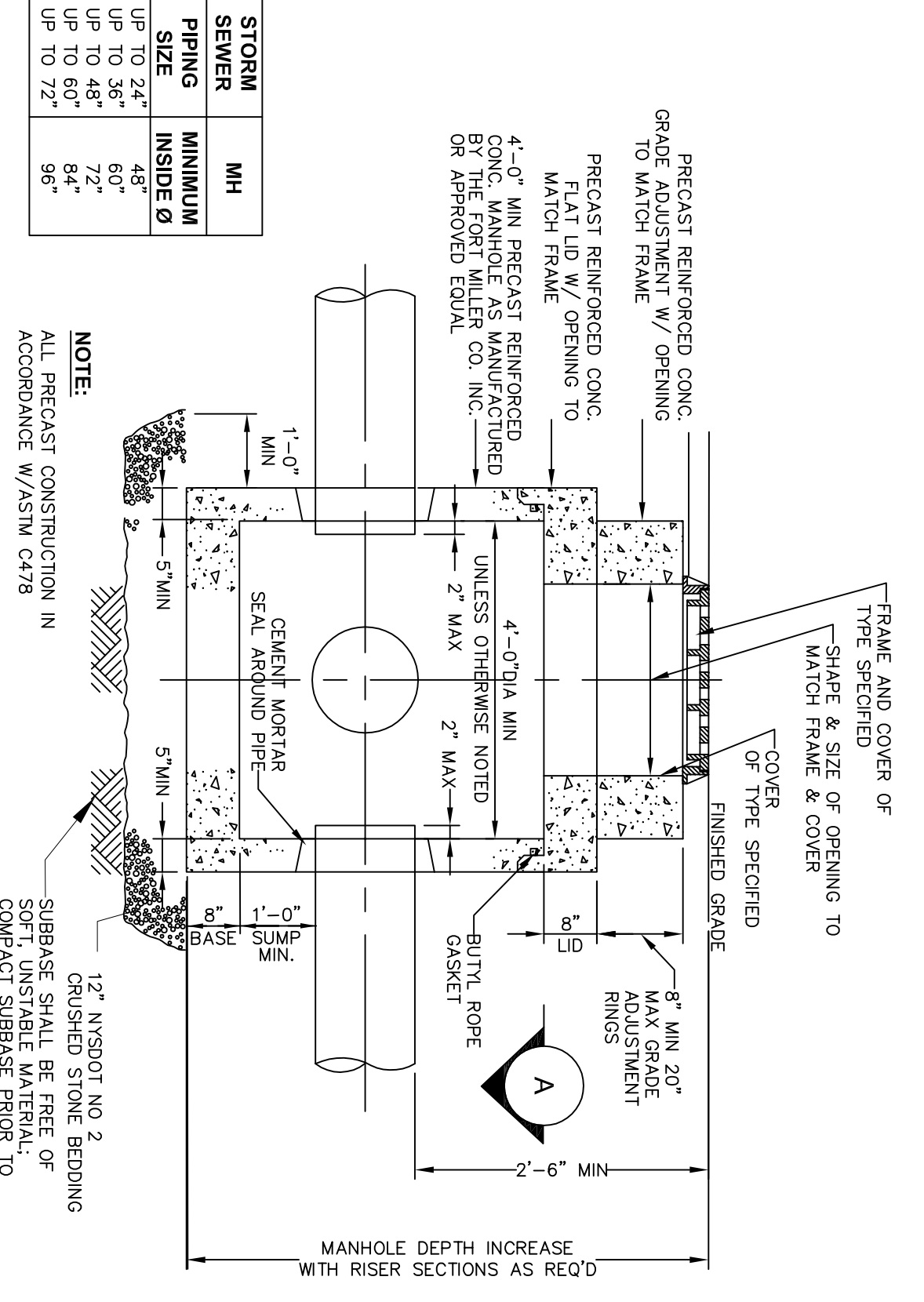

**PRECAST CONCRETE STORM SEWER
MANHOLE DETAIL**
NOT TO SCALE

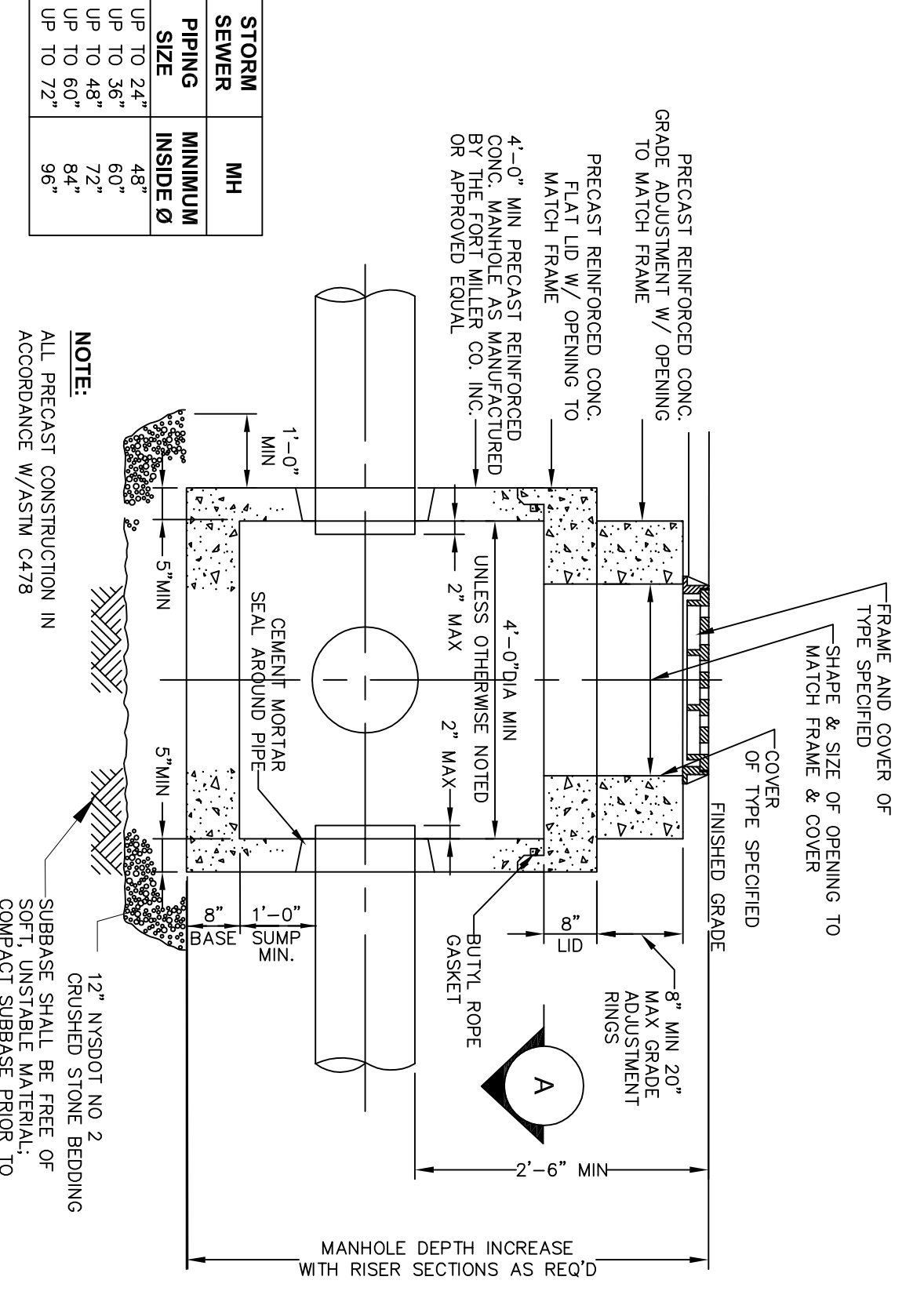

**PRECAST CONCRETE STORM SEWER
MANHOLE DETAIL**
NOT TO SCALE

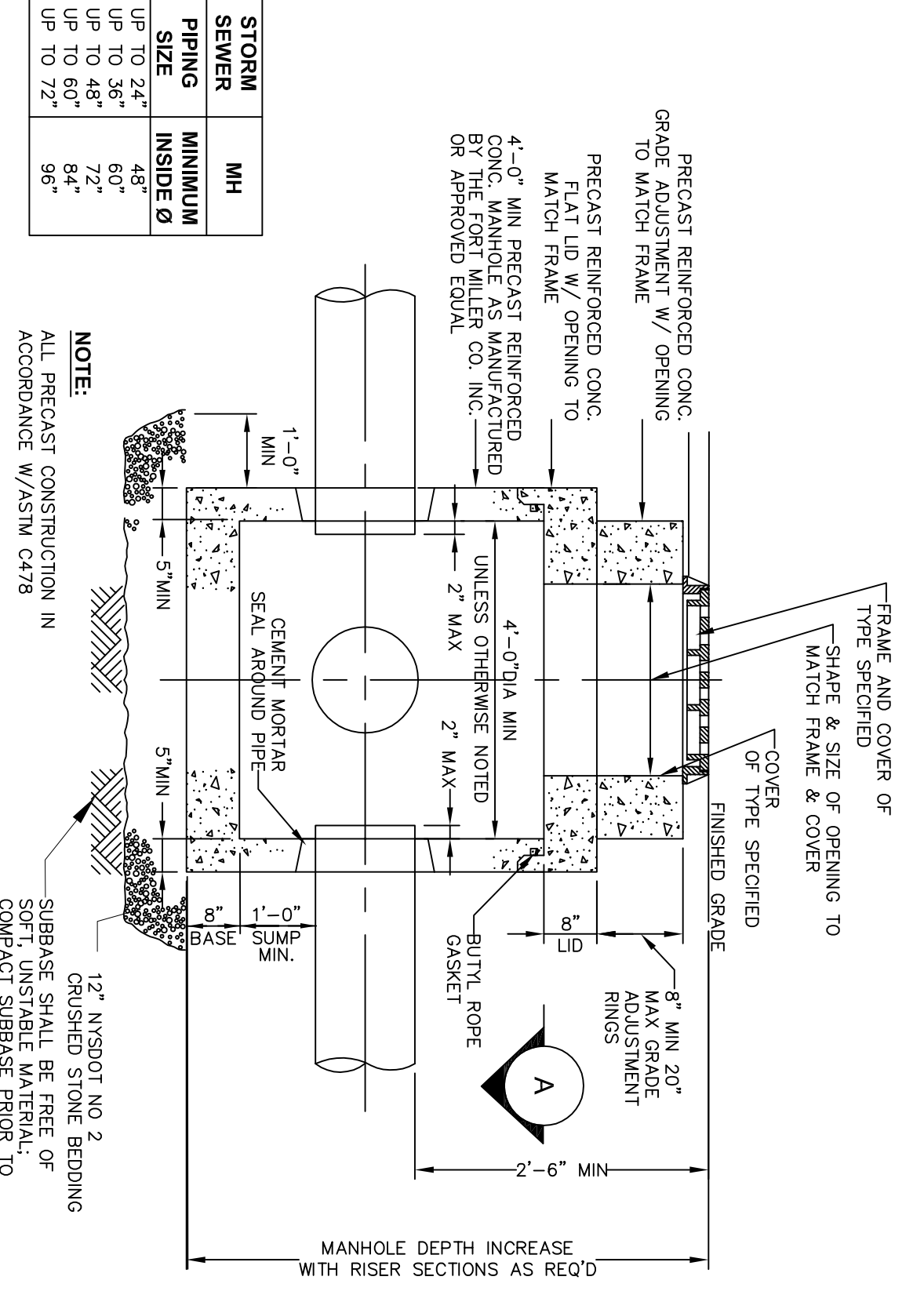

**PRECAST CONCRETE STORM SEWER
MANHOLE DETAIL**
NOT TO SCALE

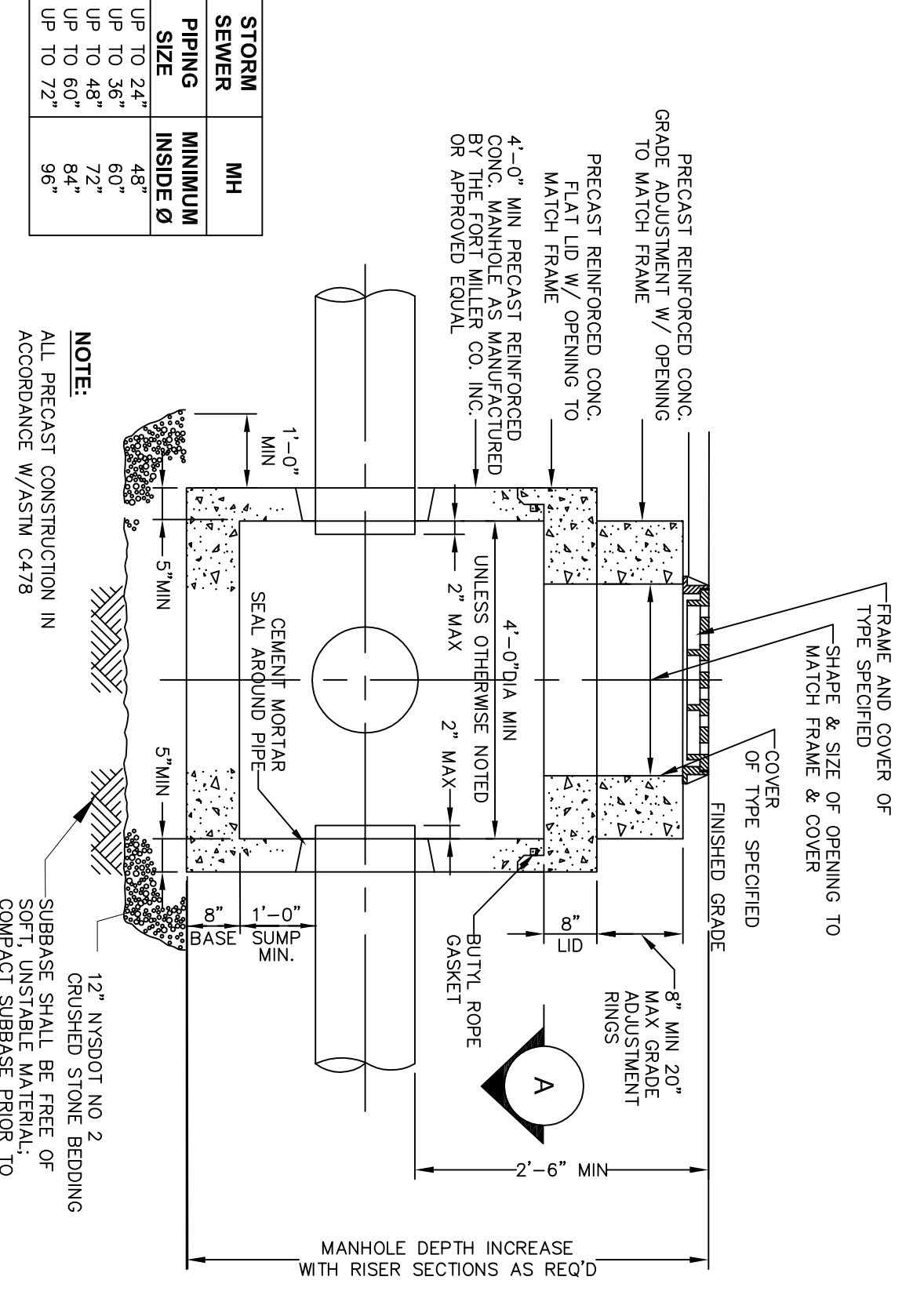

**PRECAST CONCRETE STORM SEWER
MANHOLE DETAIL**
NOT TO SCALE

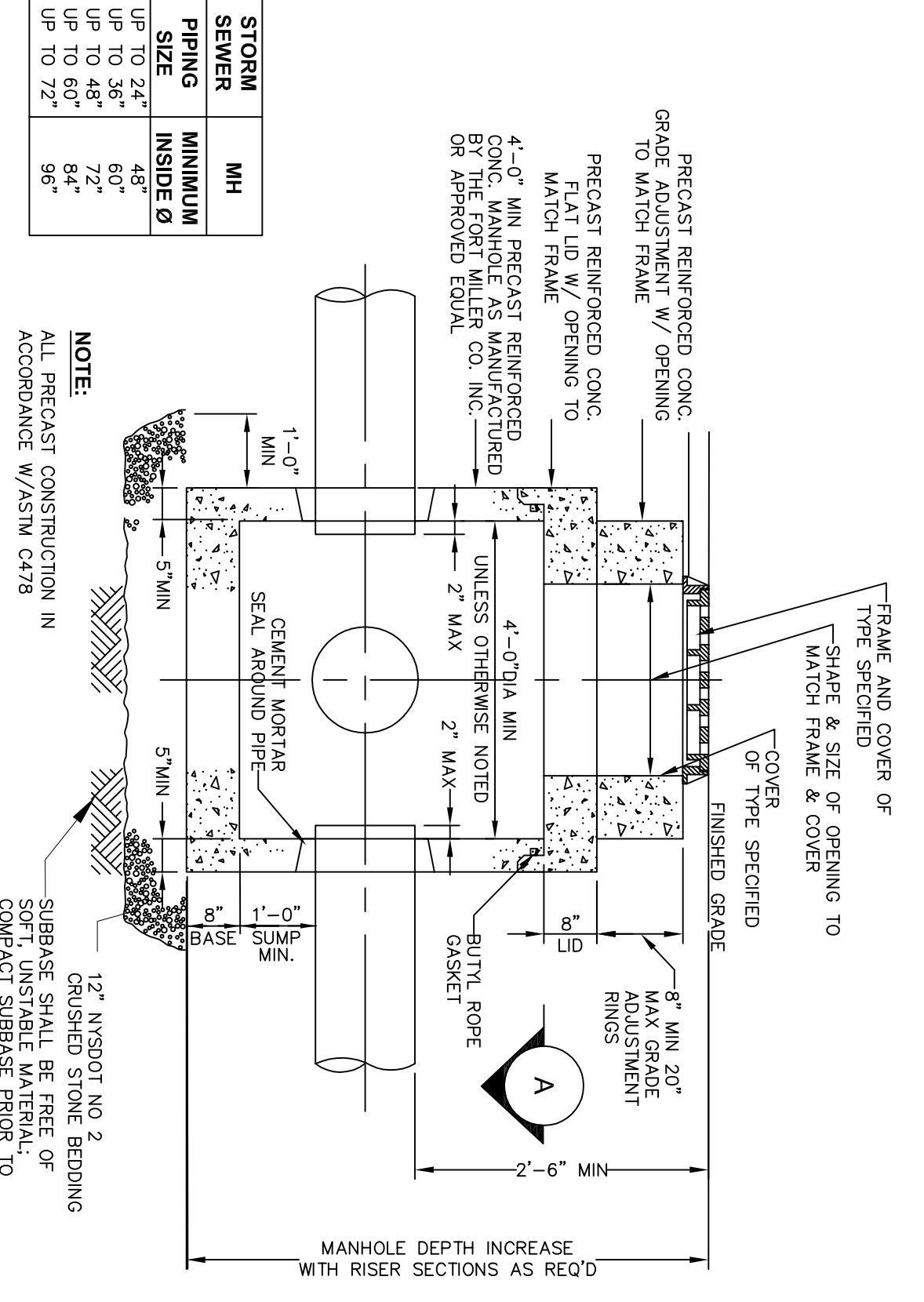

**PRECAST CONCRETE STORM SEWER
MANHOLE DETAIL**
NOT TO SCALE

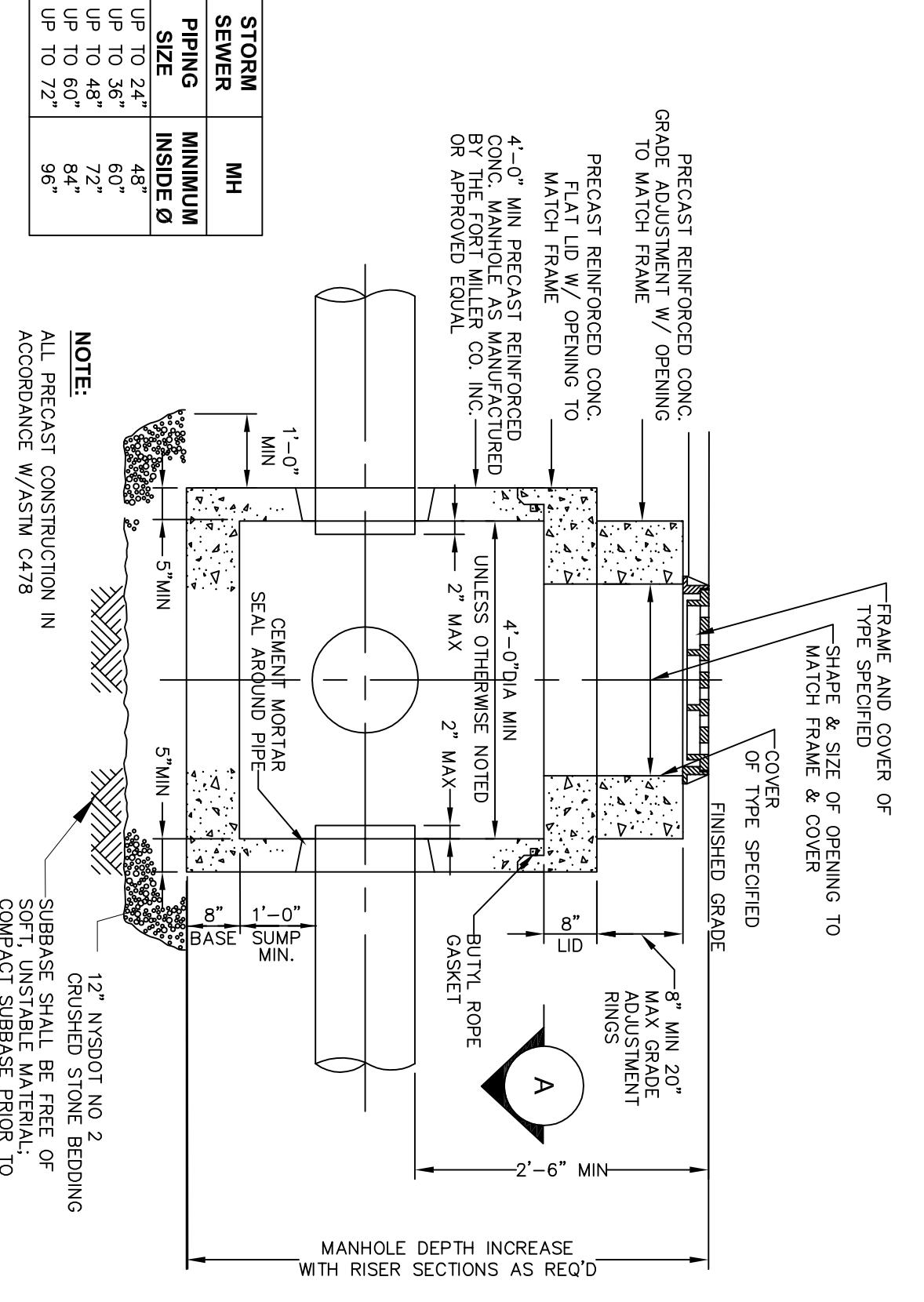

**PRECAST CONCRETE STORM SEWER
MANHOLE DETAIL**
NOT TO SCALE

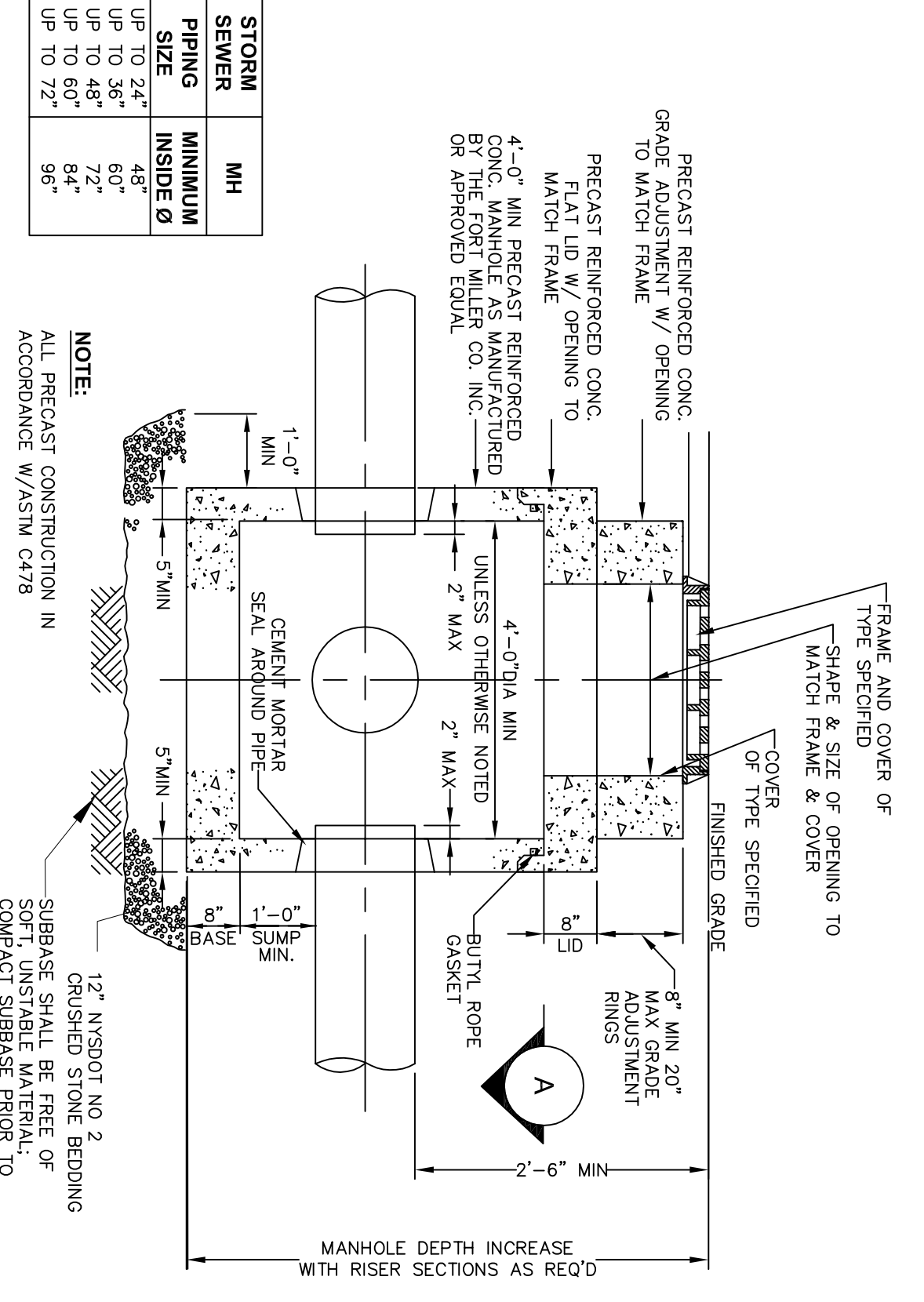

**PRECAST CONCRETE STORM SEWER
MANHOLE DETAIL**
NOT TO SCALE

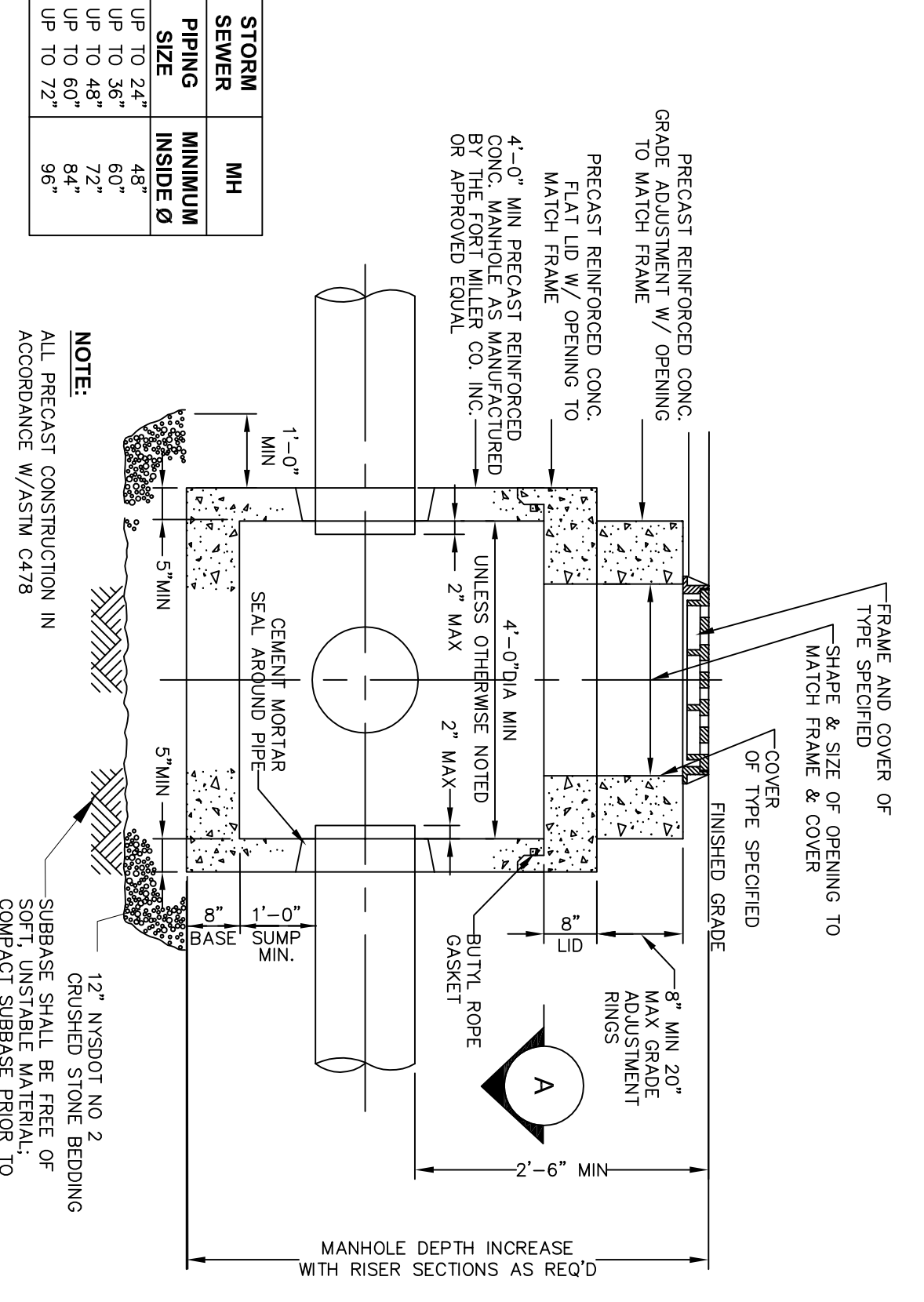

**PRECAST CONCRETE STORM SEWER
MANHOLE DETAIL**
NOT TO SCALE

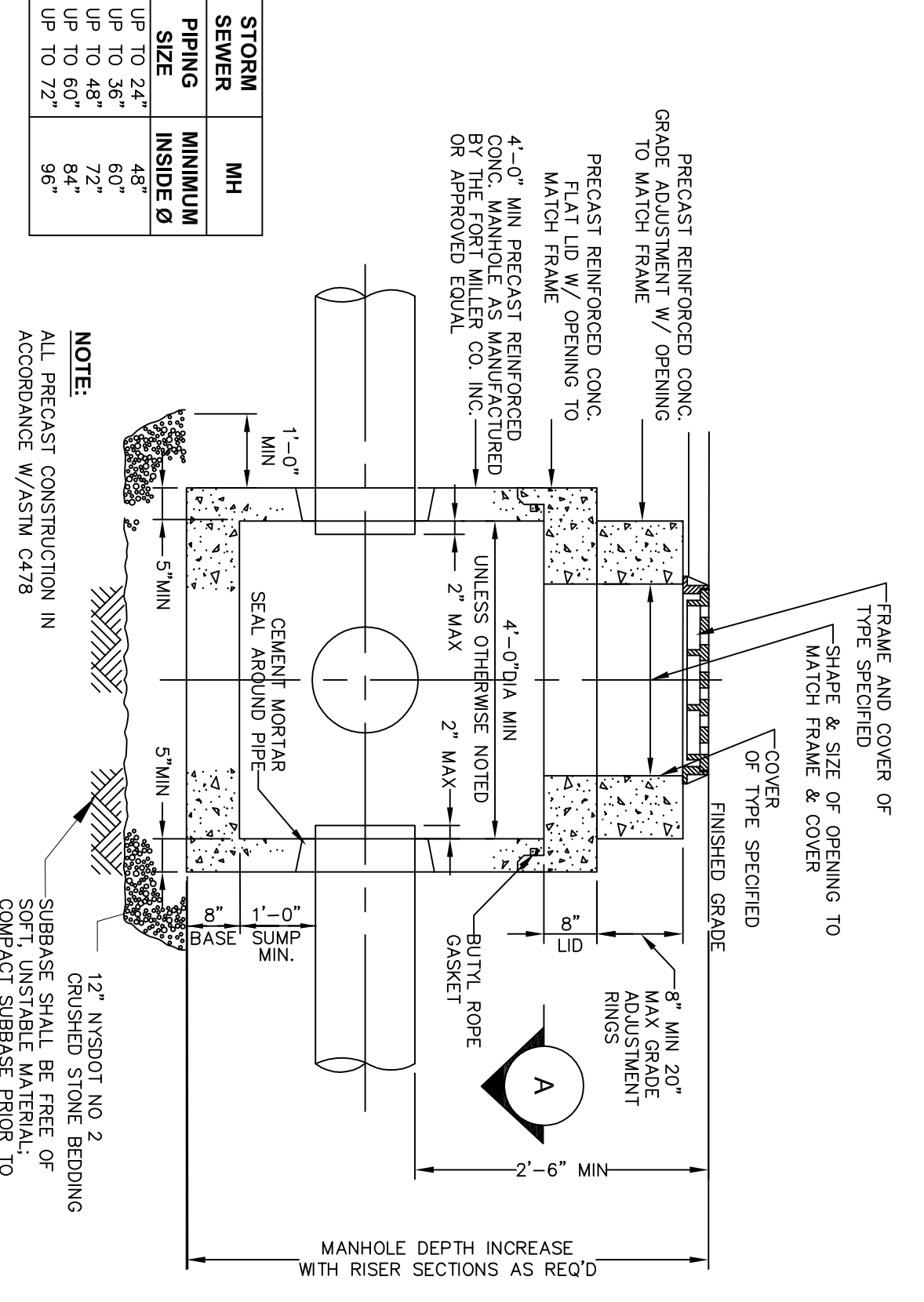

**PRECAST CONCRETE STORM SEWER
MANHOLE DETAIL**
NOT TO SCALE

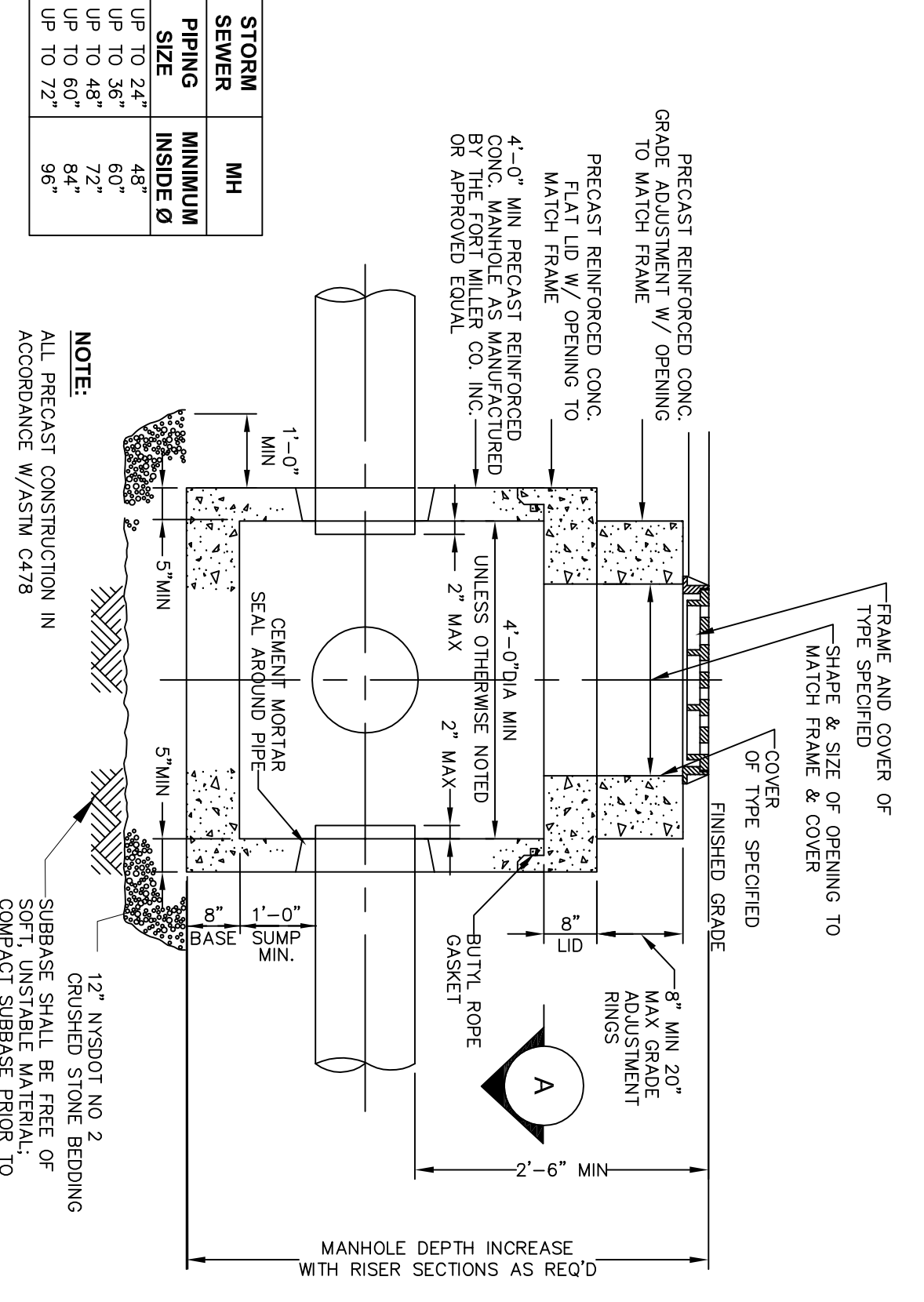

**PRECAST CONCRETE STORM SEWER
MANHOLE DETAIL**
NOT TO SCALE

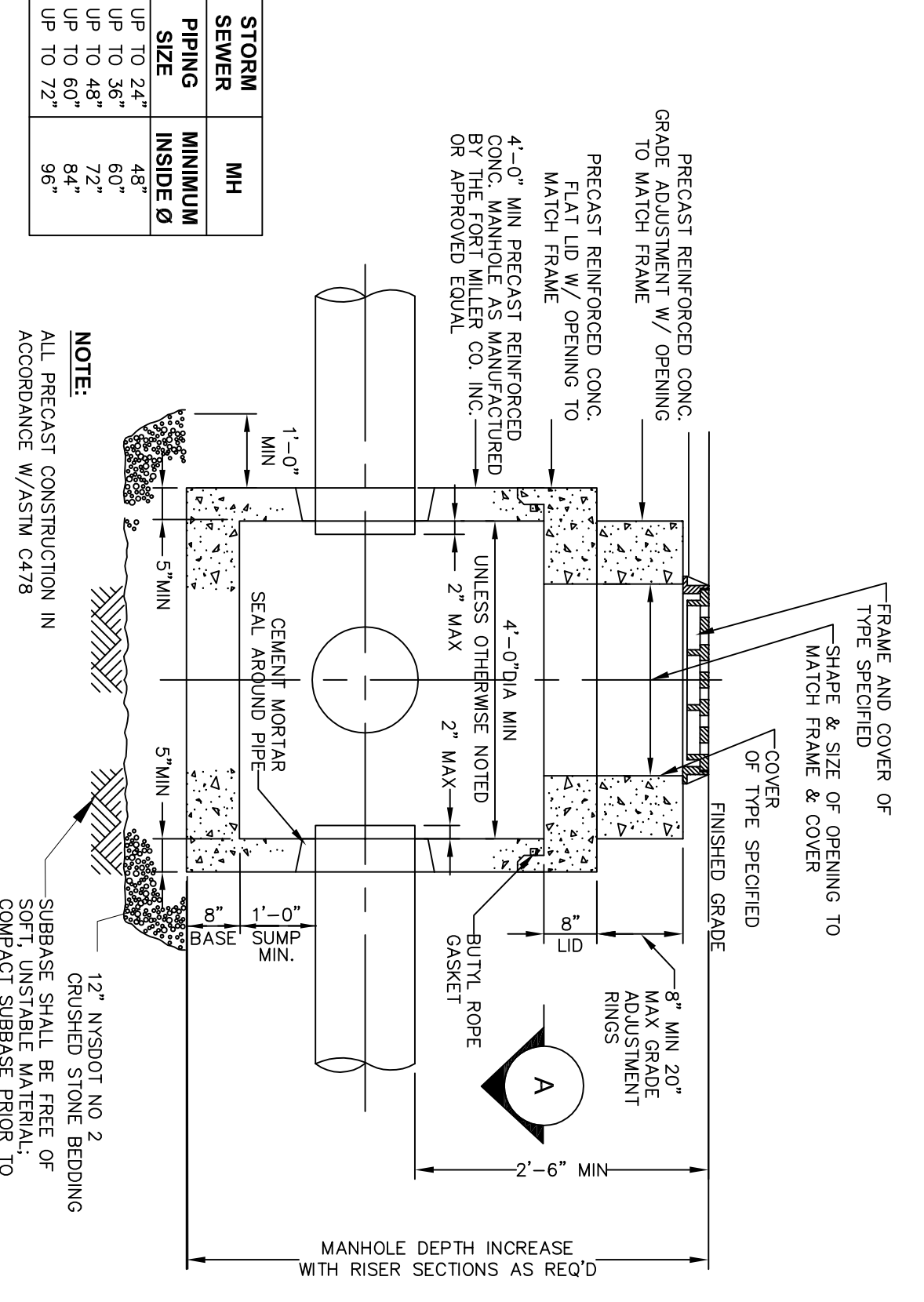

**PRECAST CONCRETE STORM SEWER
MANHOLE DETAIL**
NOT TO SCALE

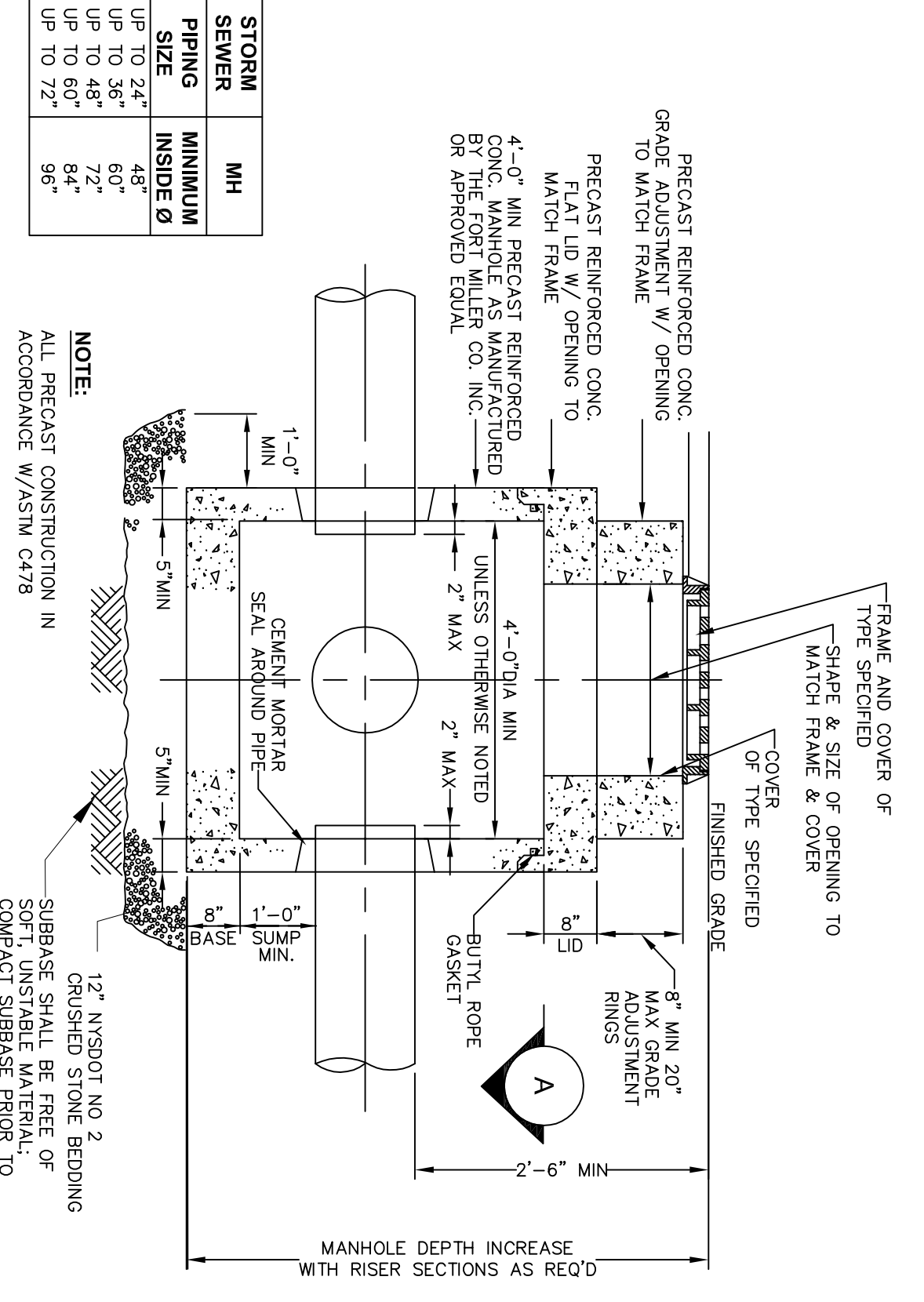

**PRECAST CONCRETE STORM SEWER
MANHOLE DETAIL**
NOT TO SCALE

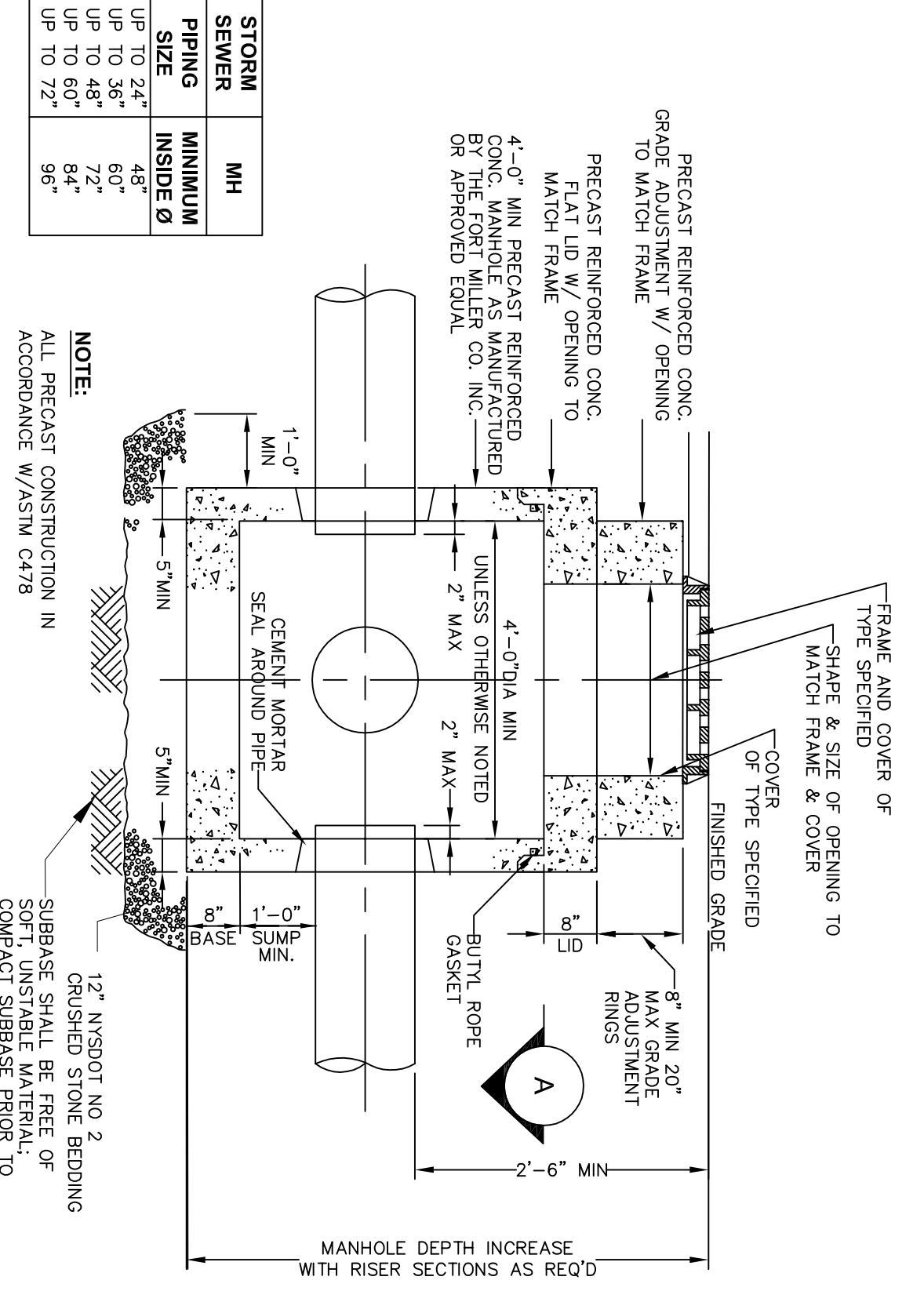

**PRECAST CONCRETE STORM SEWER
MANHOLE DETAIL**
NOT TO SCALE

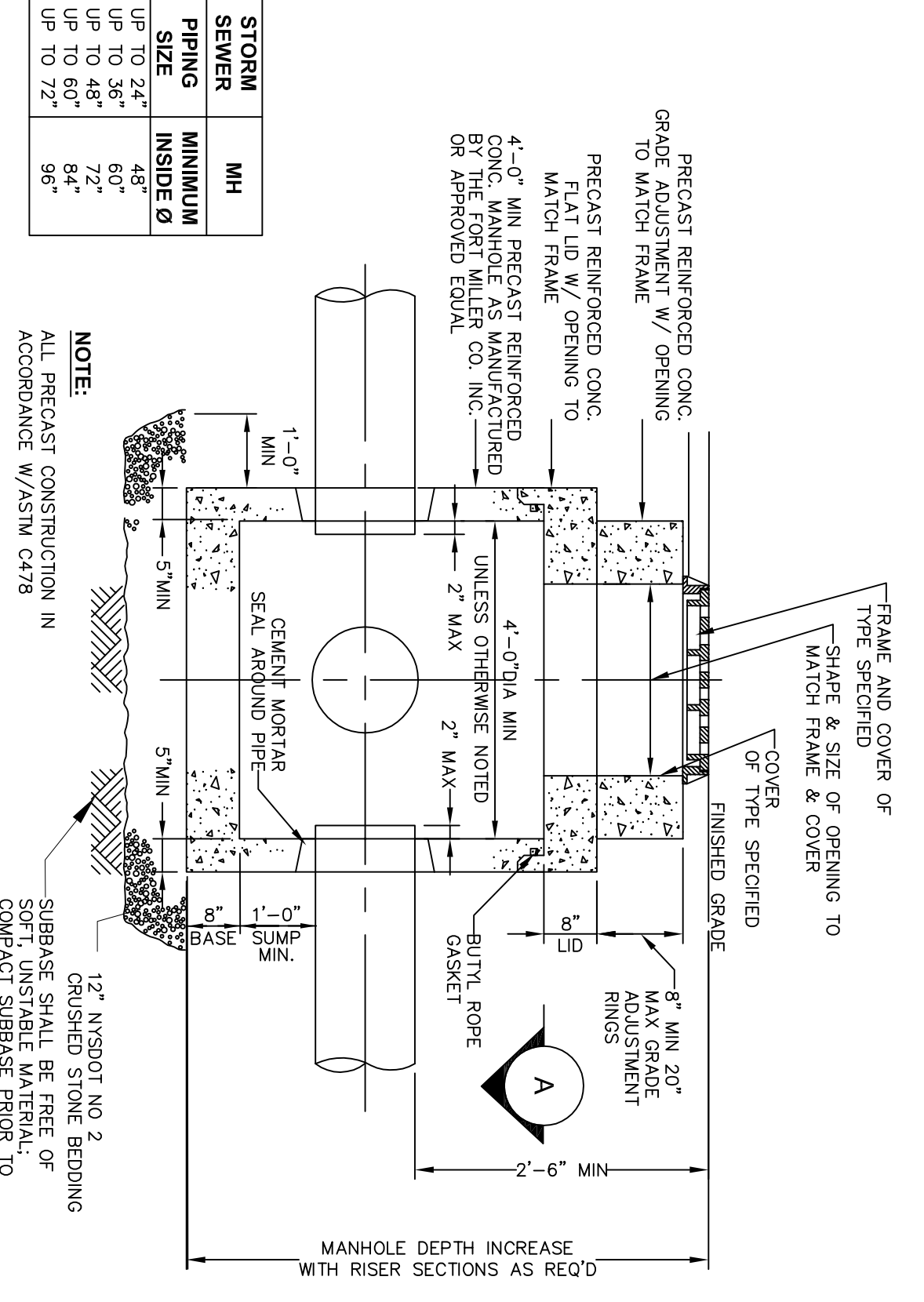

**PRECAST CONCRETE STORM SEWER
MANHOLE DETAIL**
NOT TO SCALE

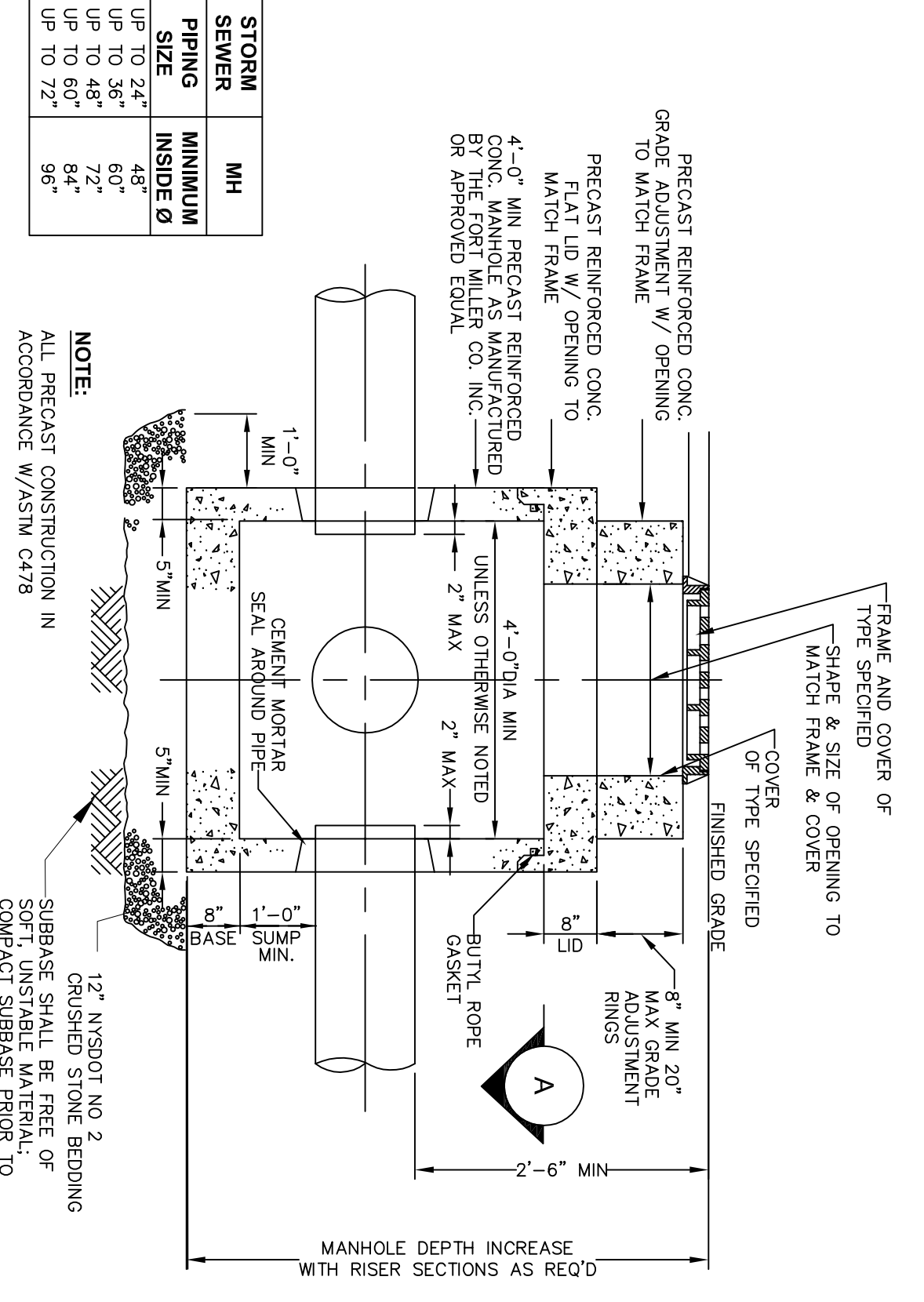

**PRECAST CONCRETE STORM SEWER
MANHOLE DETAIL**
NOT TO SCALE

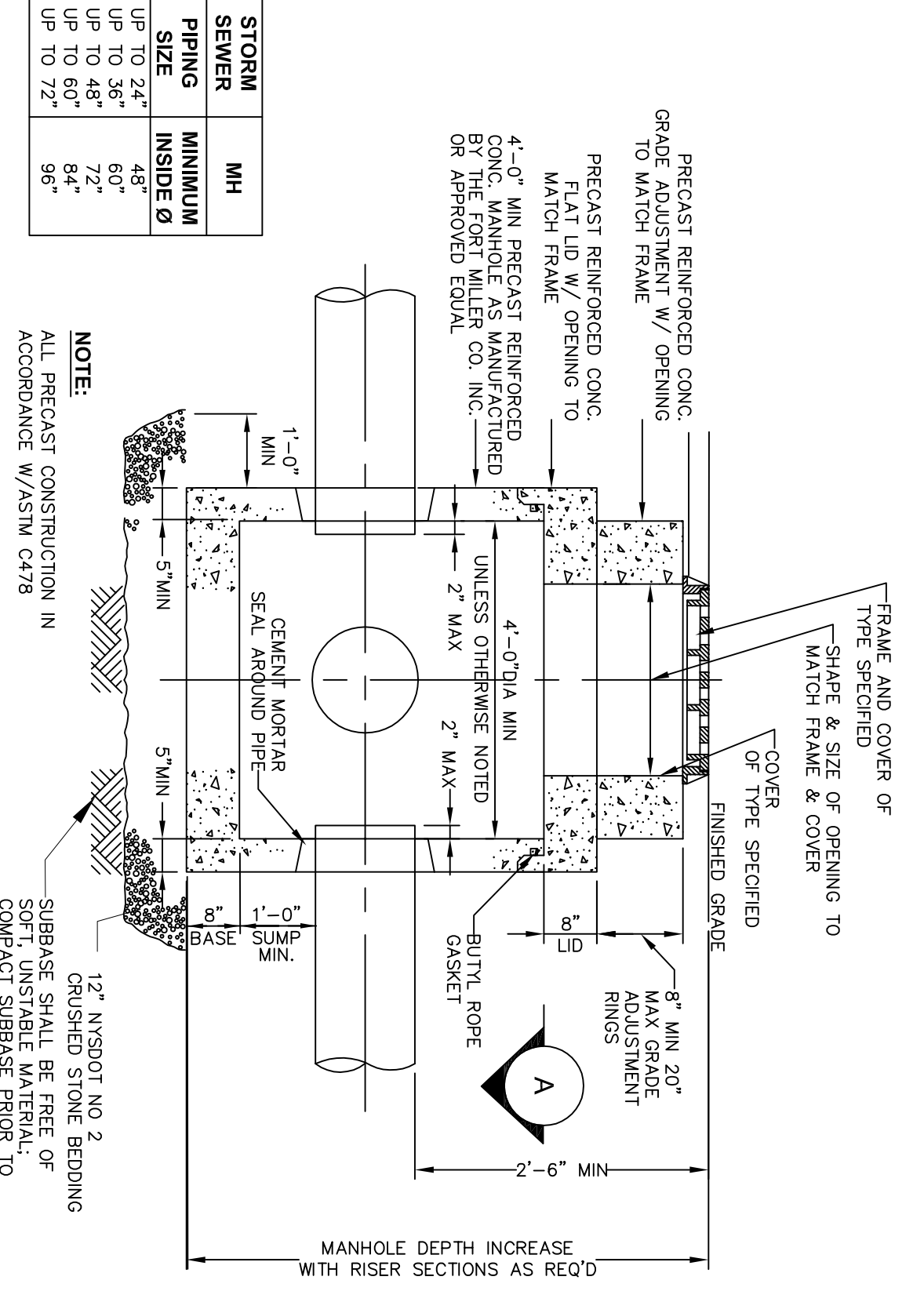

**PRECAST CONCRETE STORM SEWER
MANHOLE DETAIL**
NOT TO SCALE

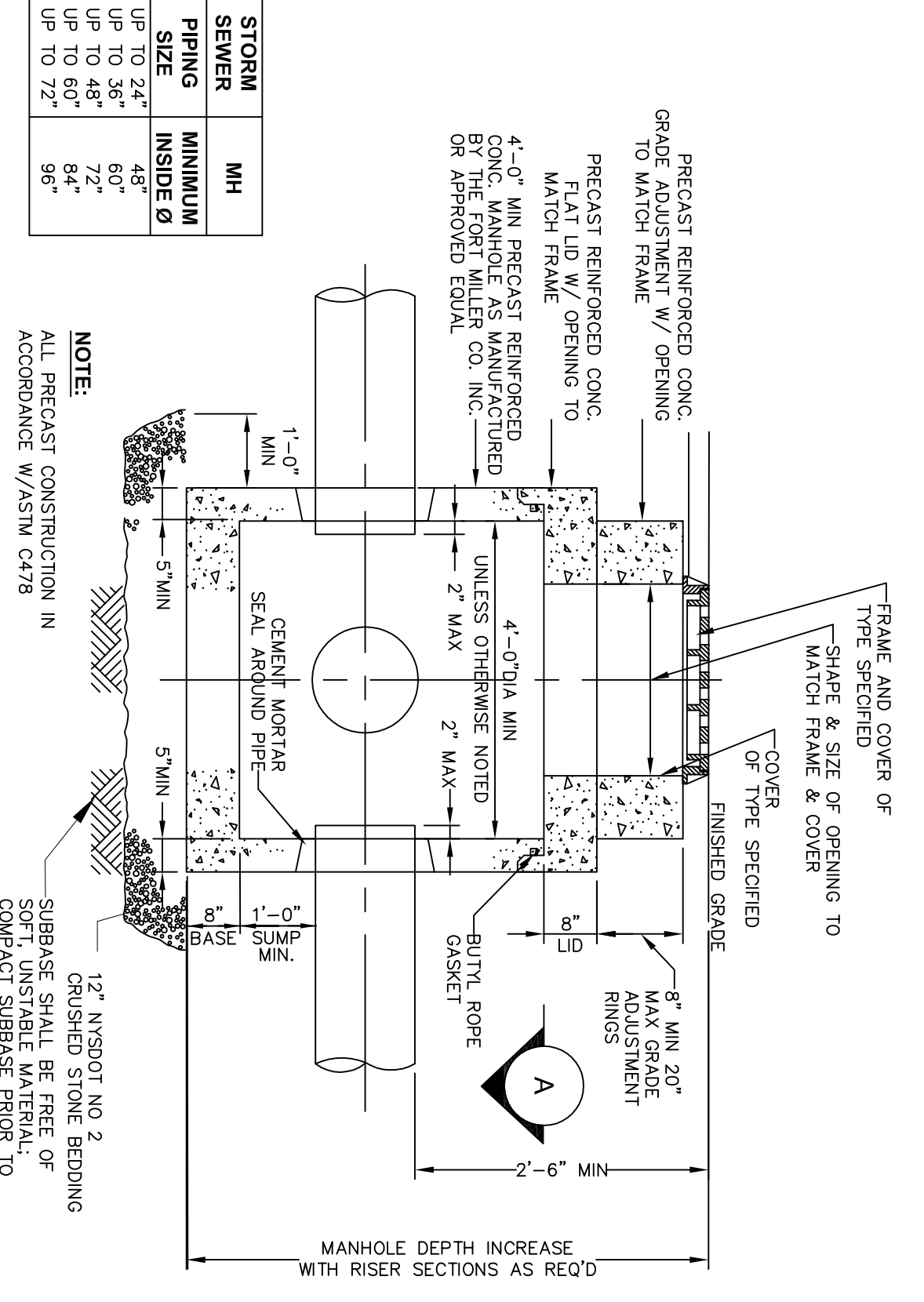

**PRECAST CONCRETE STORM SEWER
MANHOLE DETAIL**
NOT TO SCALE

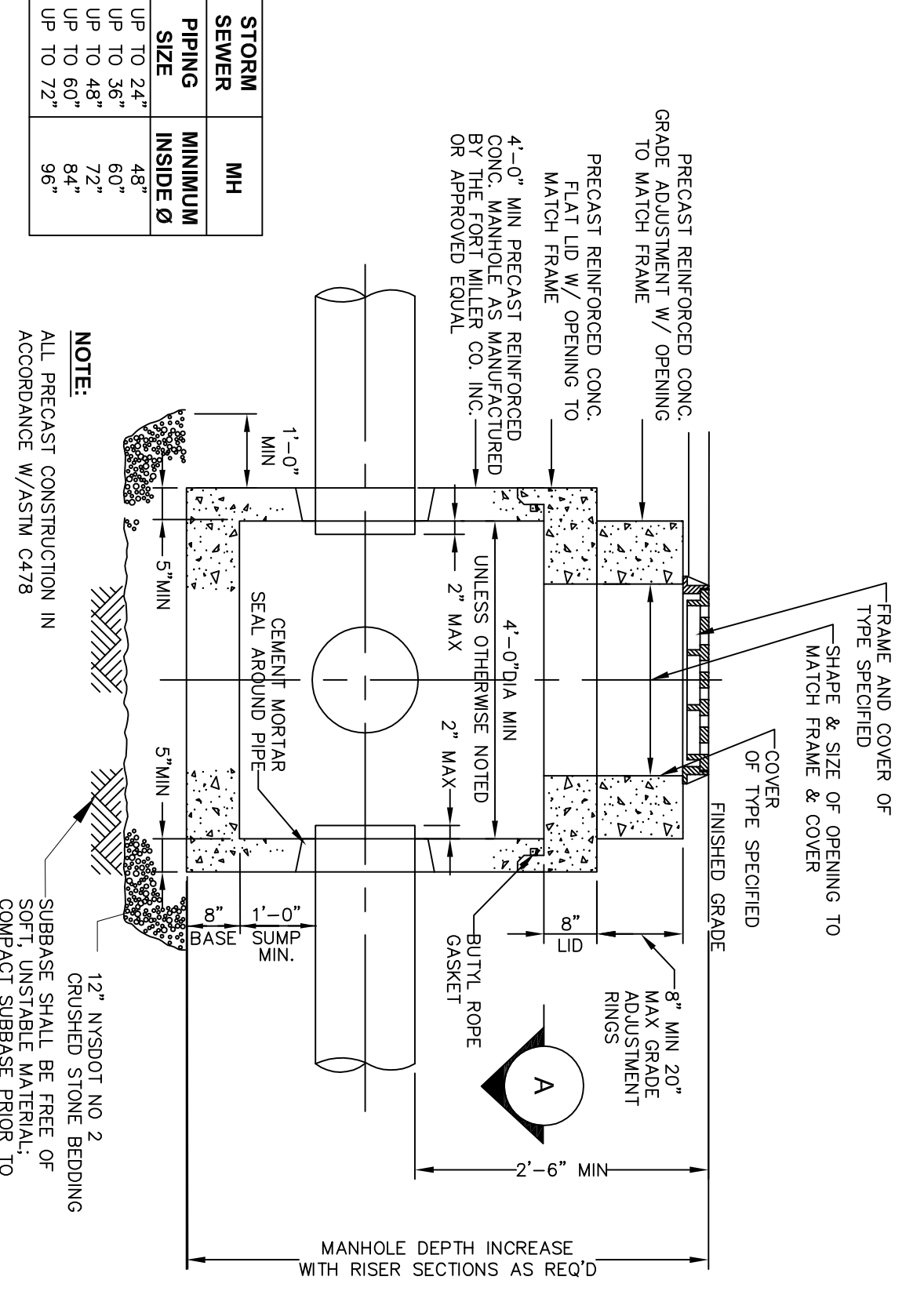

**PRECAST CONCRETE STORM SEWER
MANHOLE DETAIL**
NOT TO SCALE

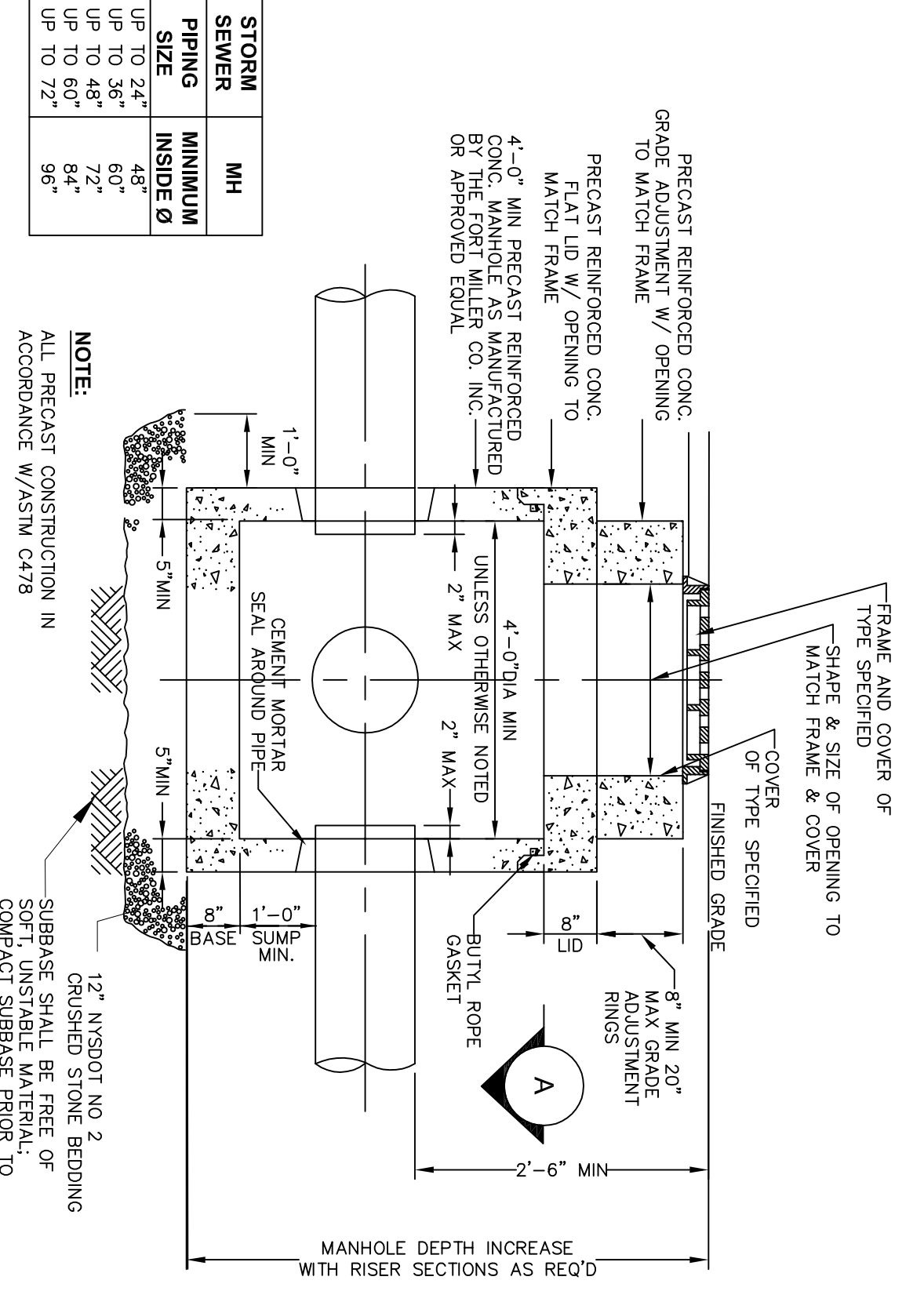

**PRECAST CONCRETE STORM SEWER
MANHOLE DETAIL**
NOT TO SCALE

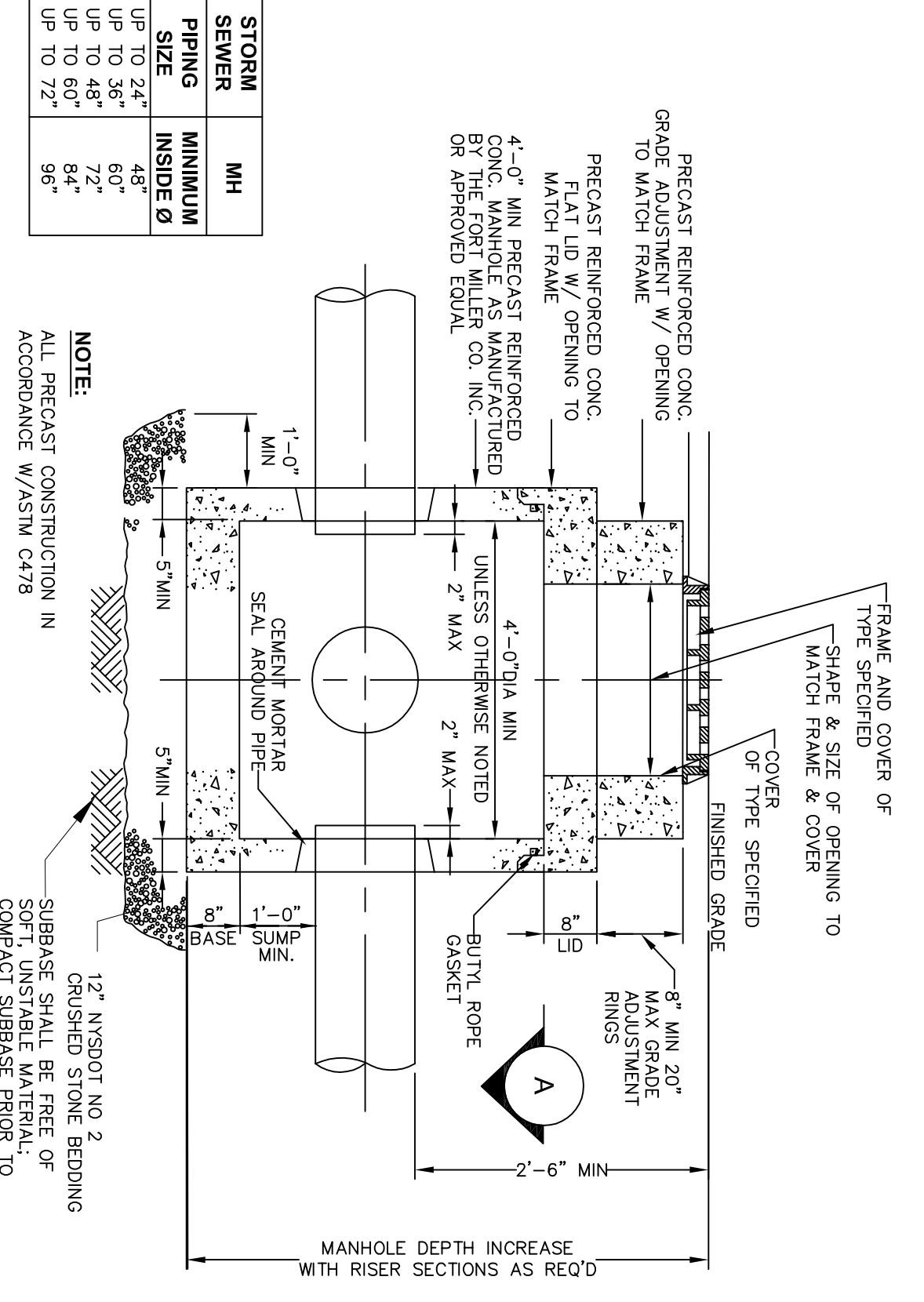

**PRECAST CONCRETE STORM SEWER
MANHOLE DETAIL**
NOT TO SCALE

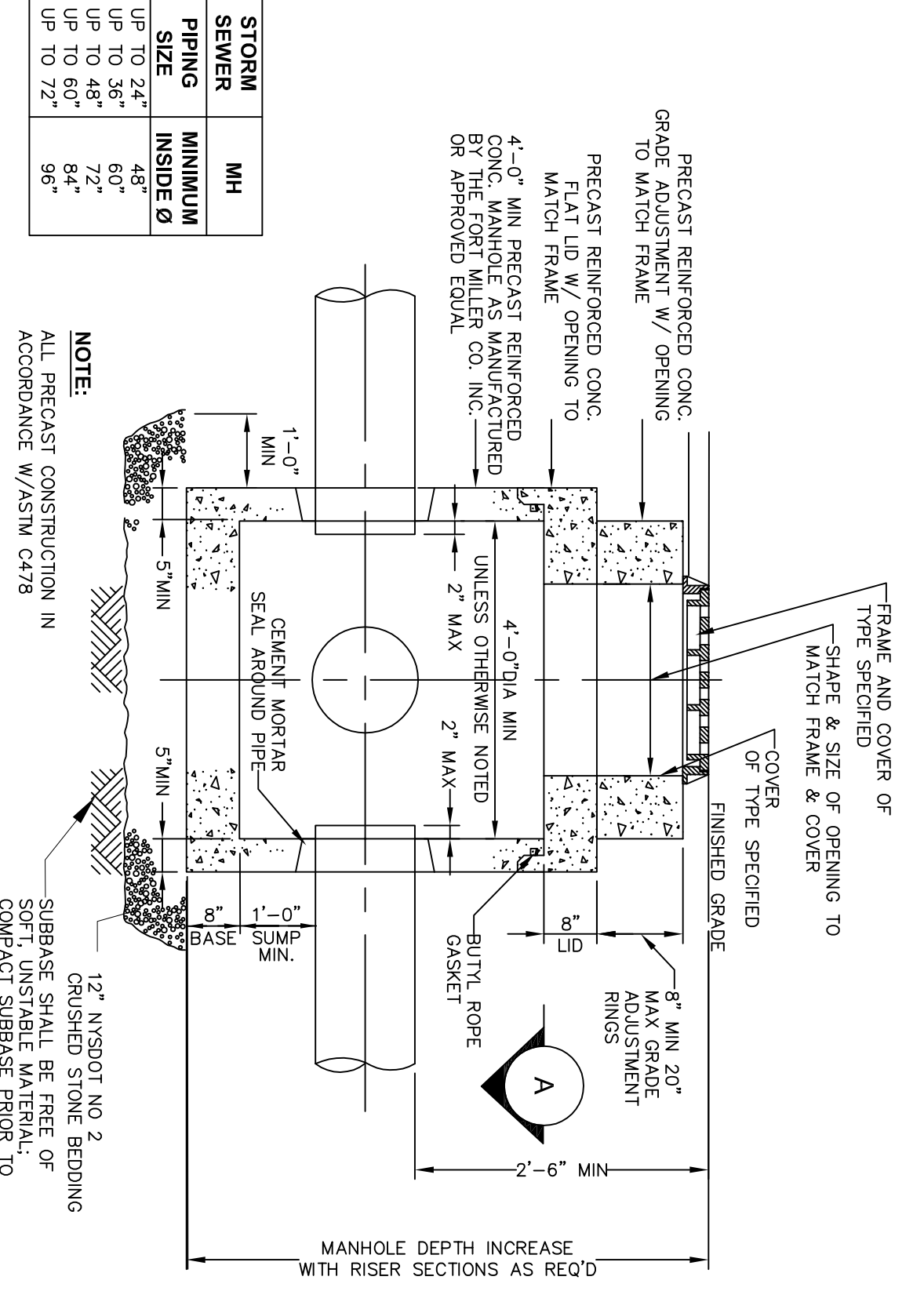

**PRECAST CONCRETE STORM SEWER
MANHOLE DETAIL**
NOT TO SCALE

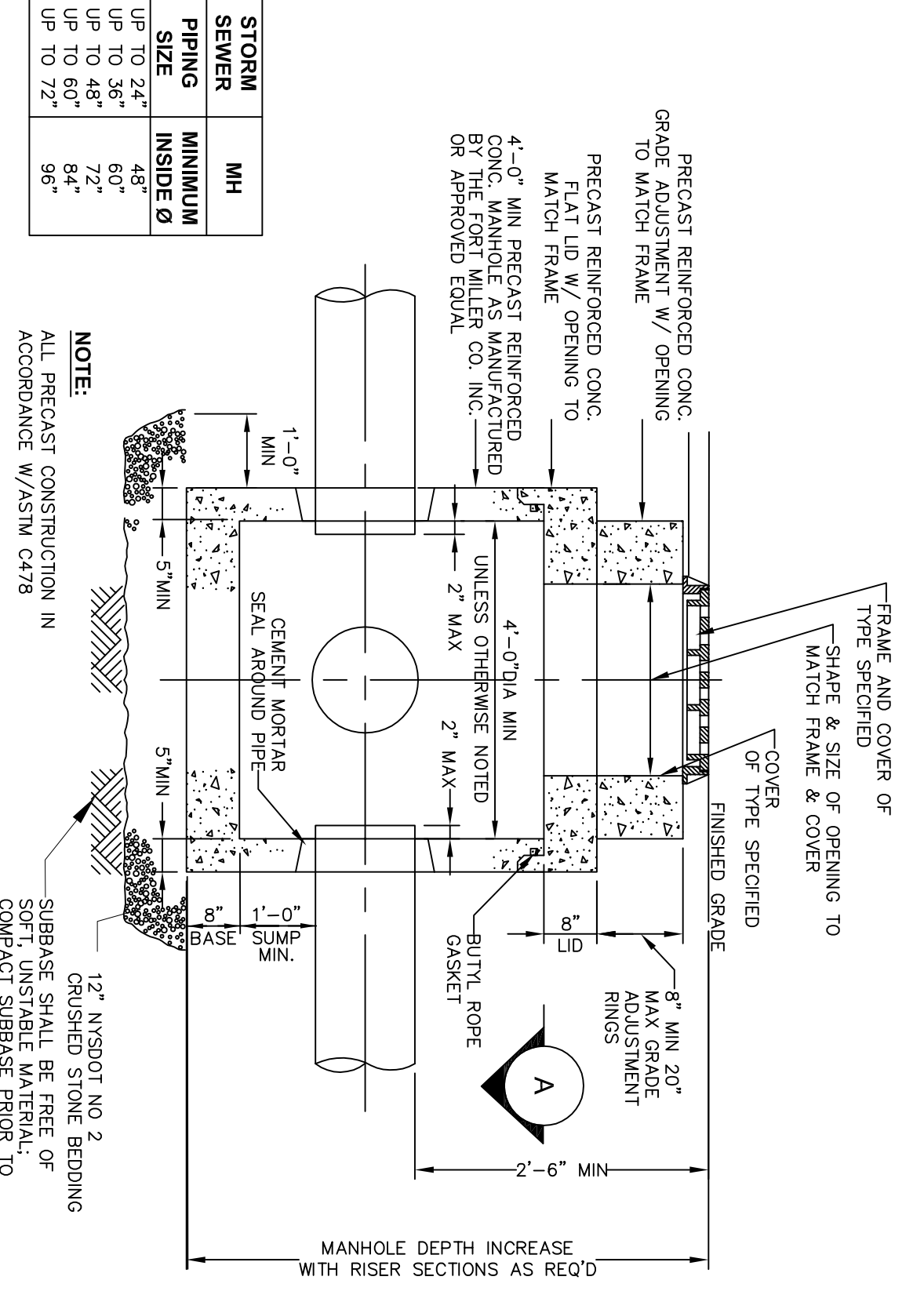

**PRECAST CONCRETE STORM SEWER
MANHOLE DETAIL**
NOT TO SCALE

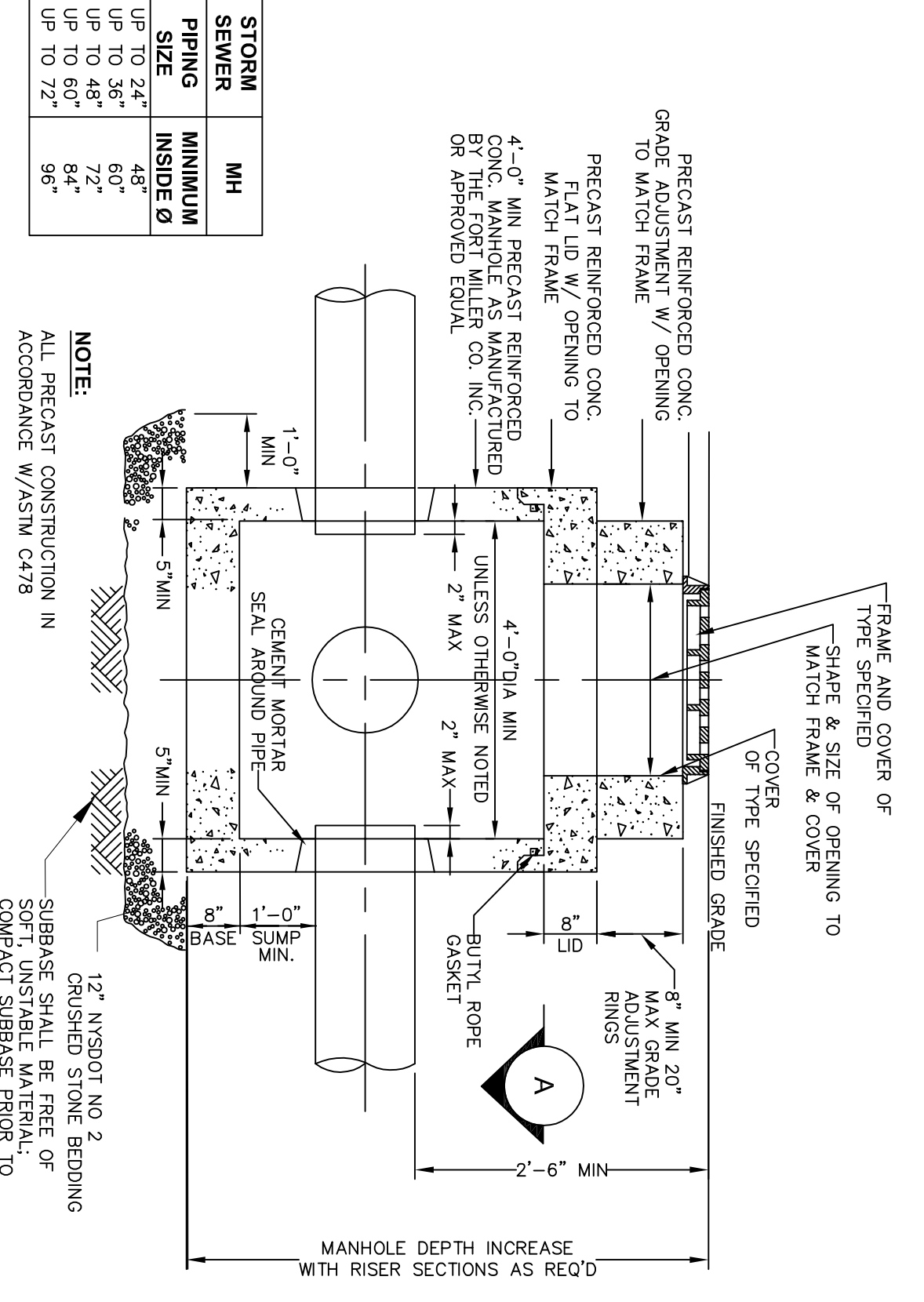

**PRECAST CONCRETE STORM SEWER
MANHOLE DETAIL**
NOT TO SCALE

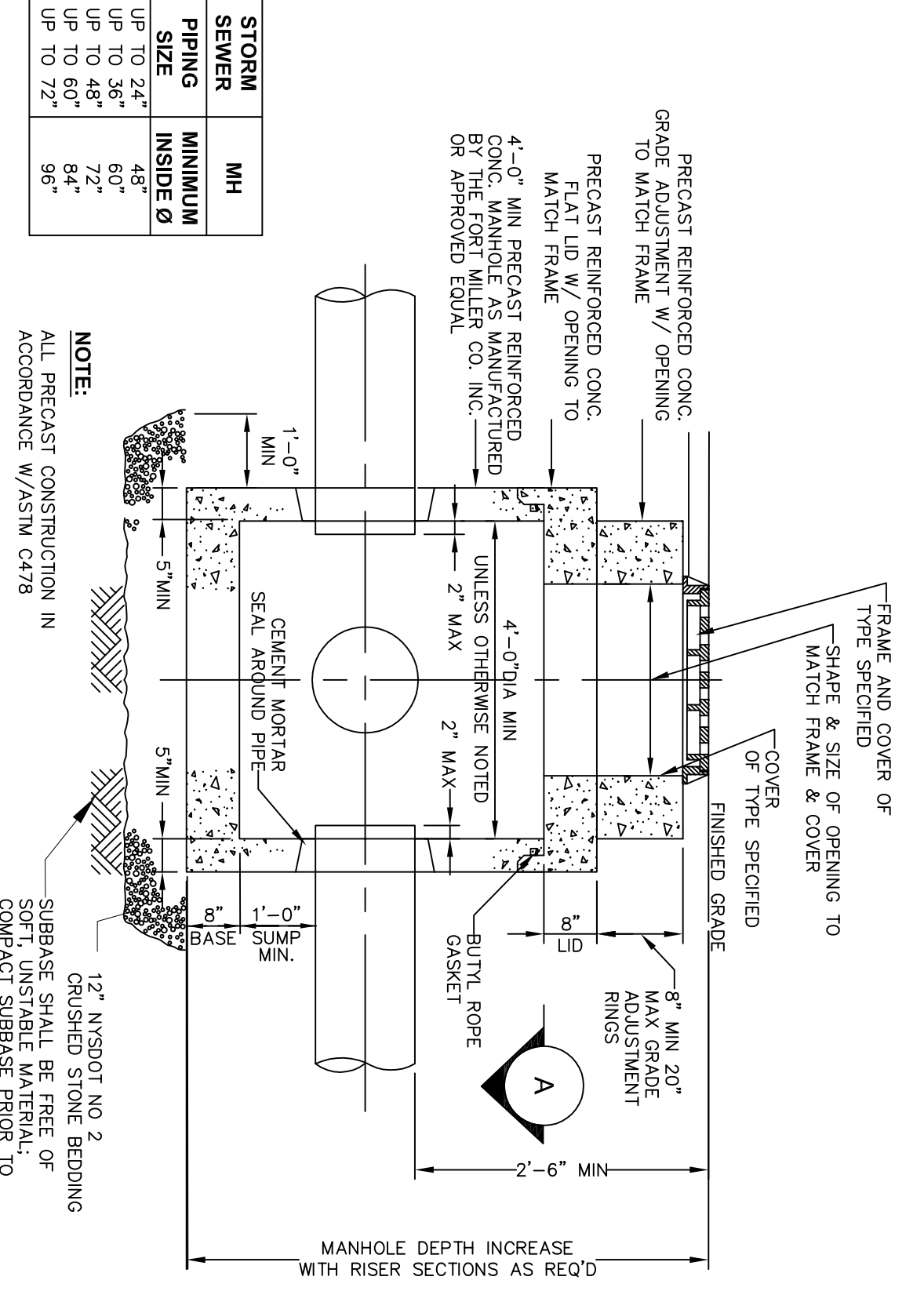

**PRECAST CONCRETE STORM SEWER
MANHOLE DETAIL**
NOT TO SCALE

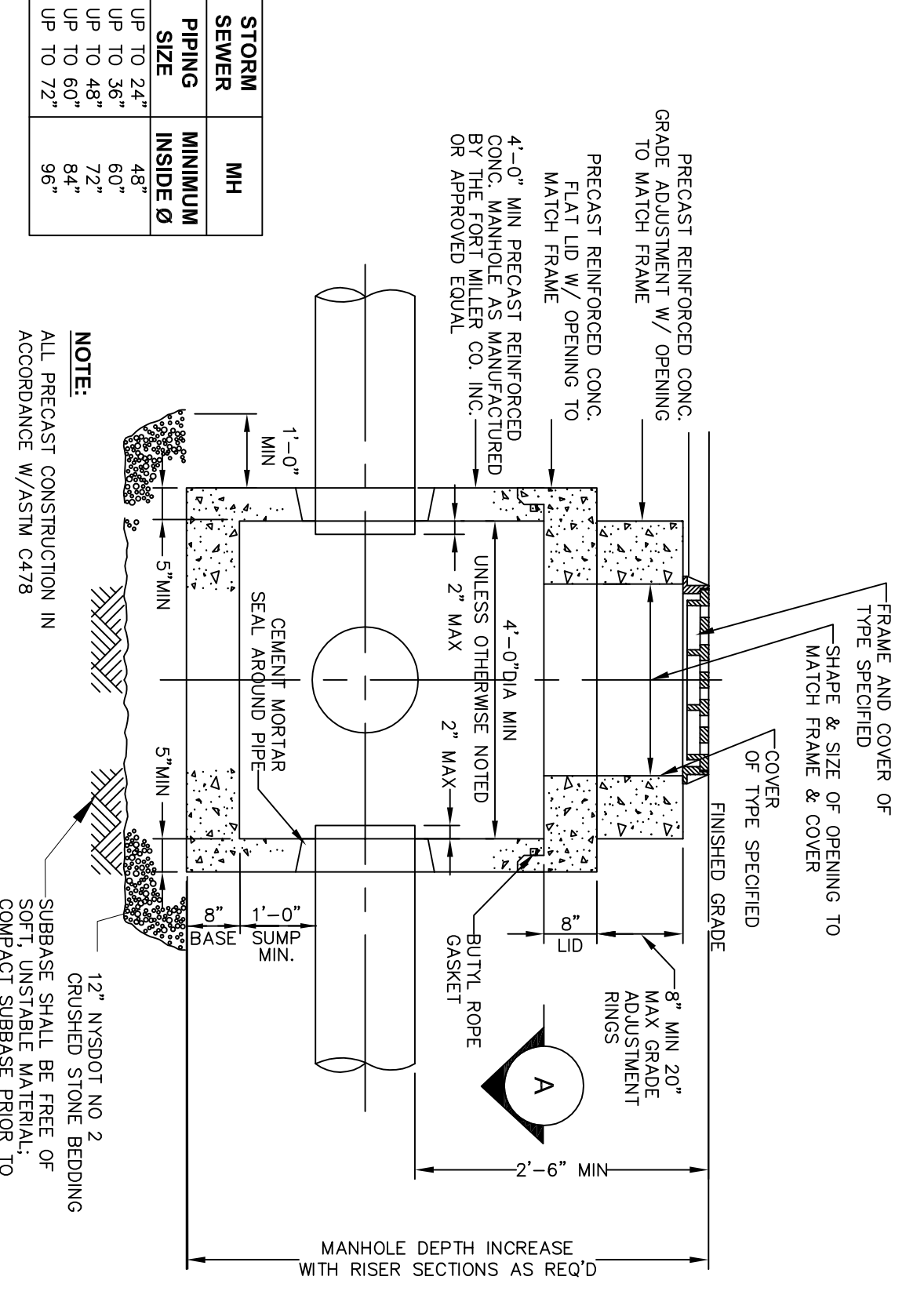

**PRECAST CONCRETE STORM SEWER
MANHOLE DETAIL**
NOT TO SCALE

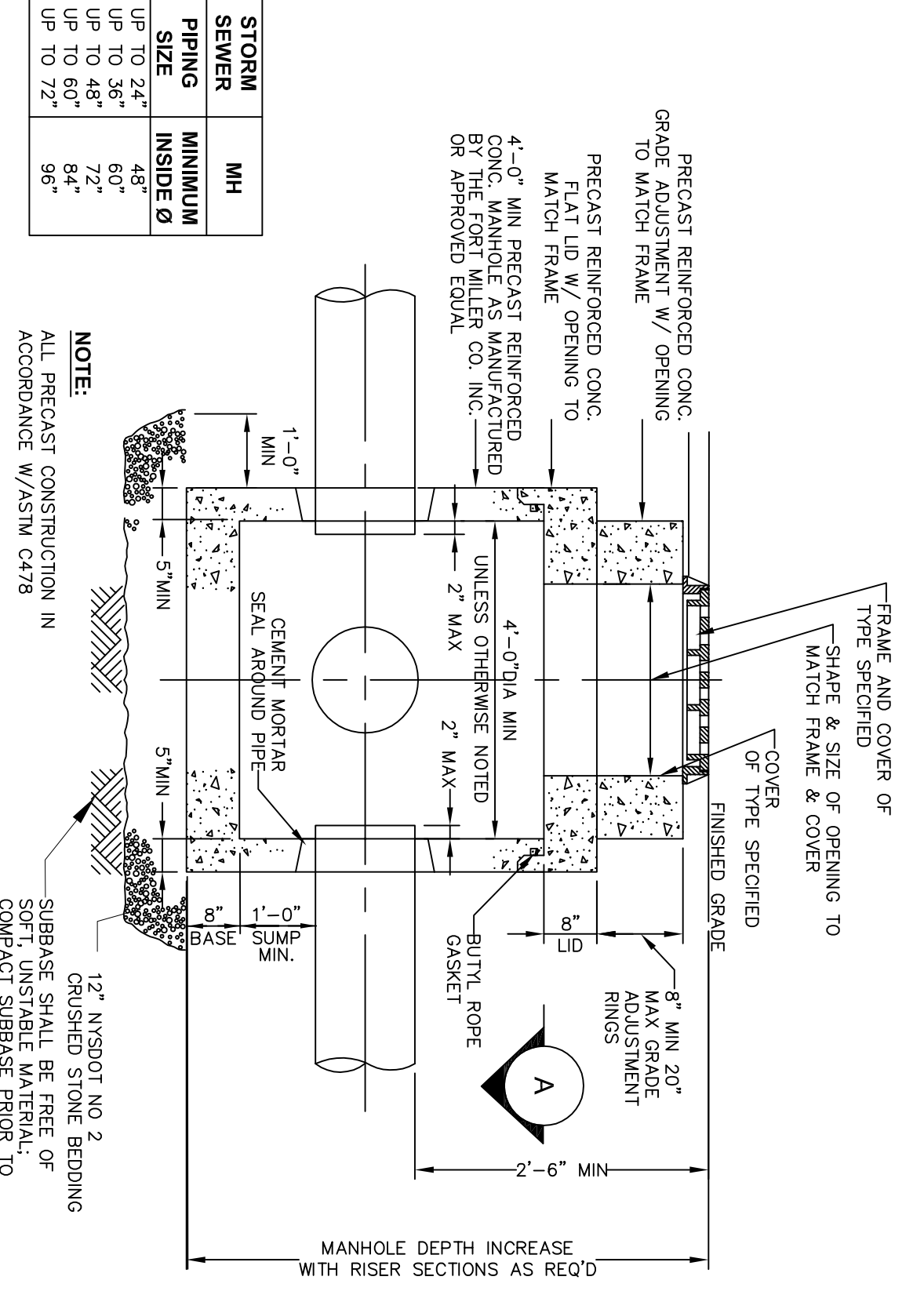

**PRECAST CONCRETE STORM SEWER
MANHOLE DETAIL**
NOT TO SCALE

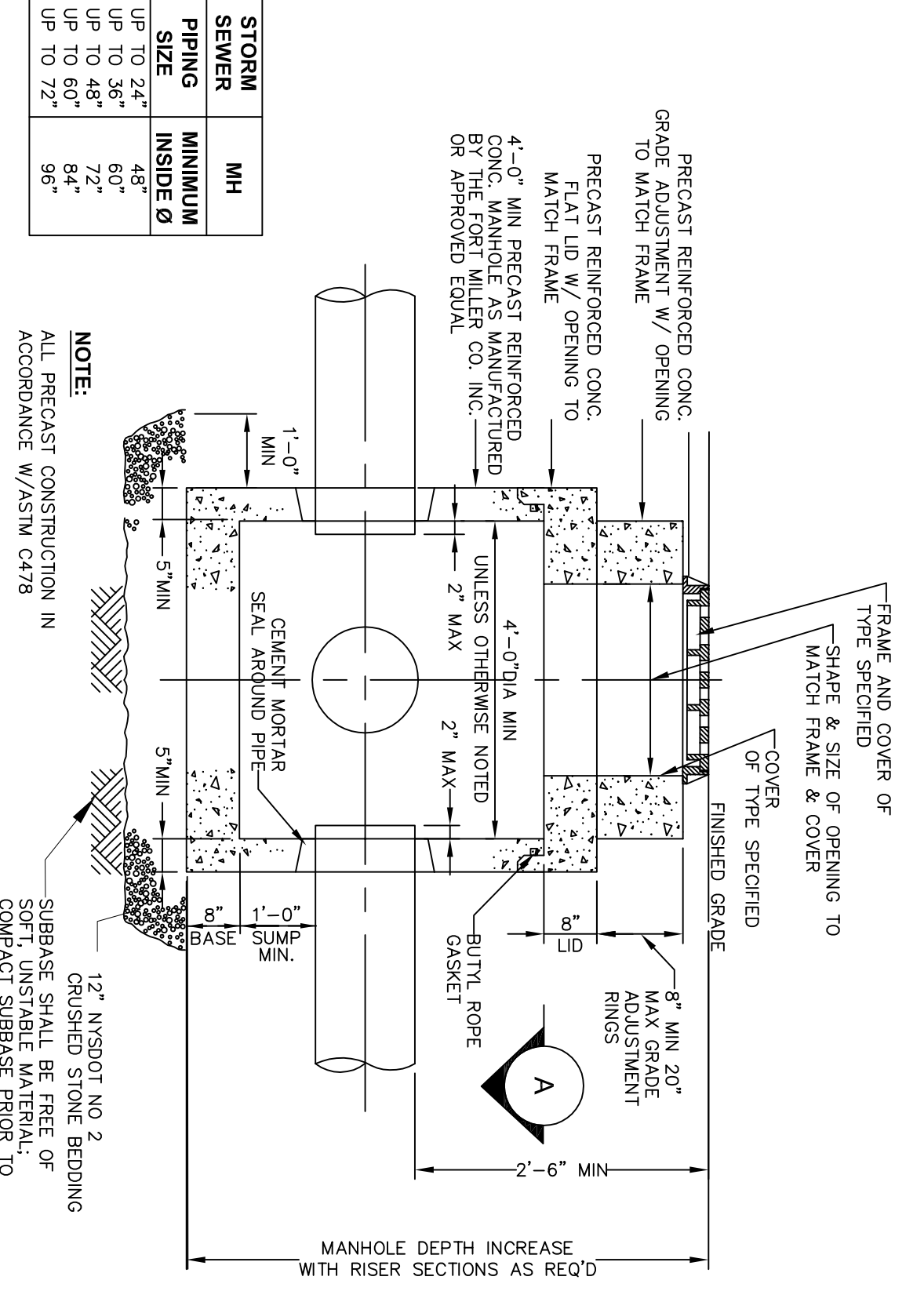

**PRECAST CONCRETE STORM SEWER
MANHOLE DETAIL**
NOT TO SCALE

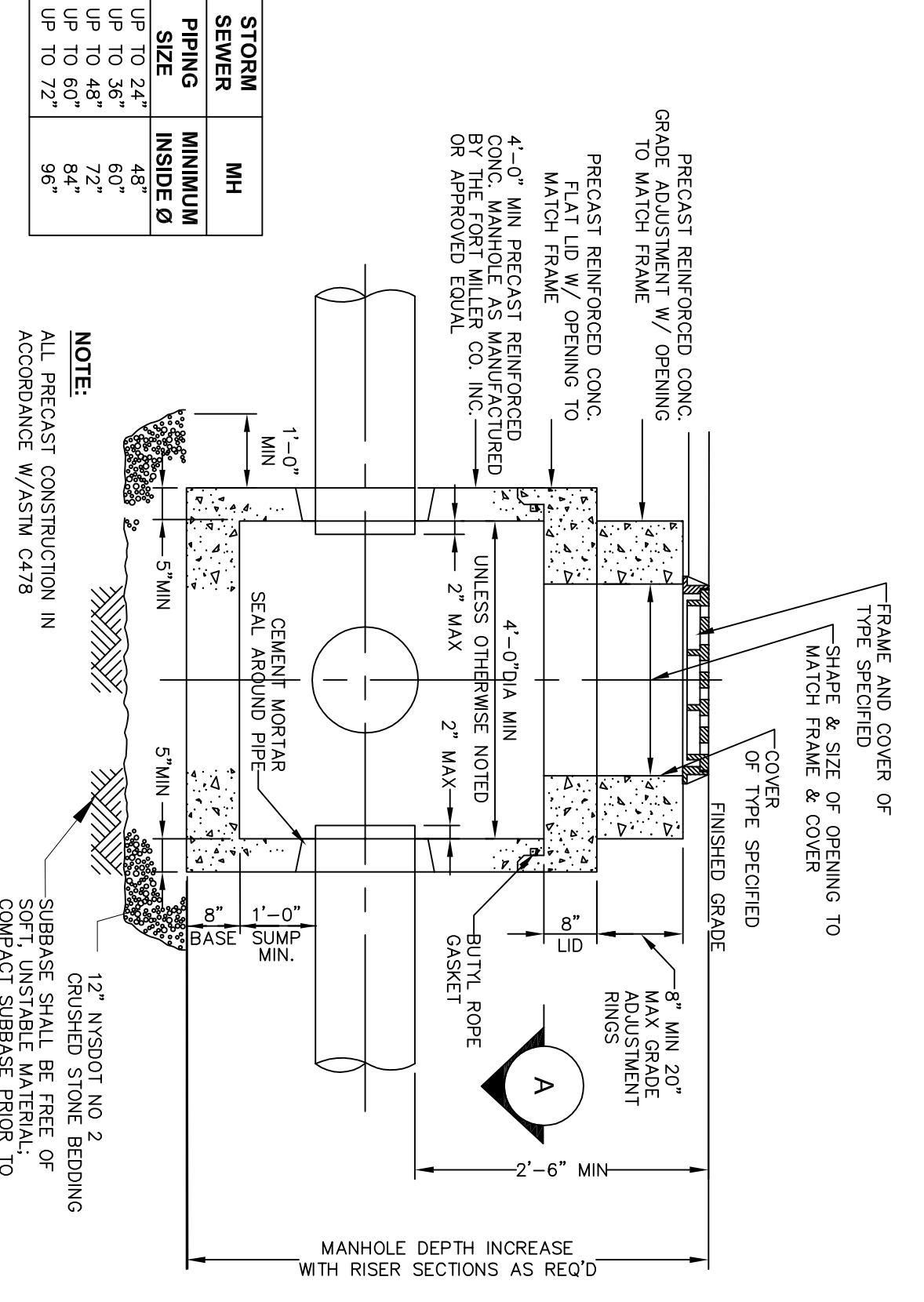

**PRECAST CONCRETE STORM SEWER
MANHOLE DETAIL**
NOT TO SCALE

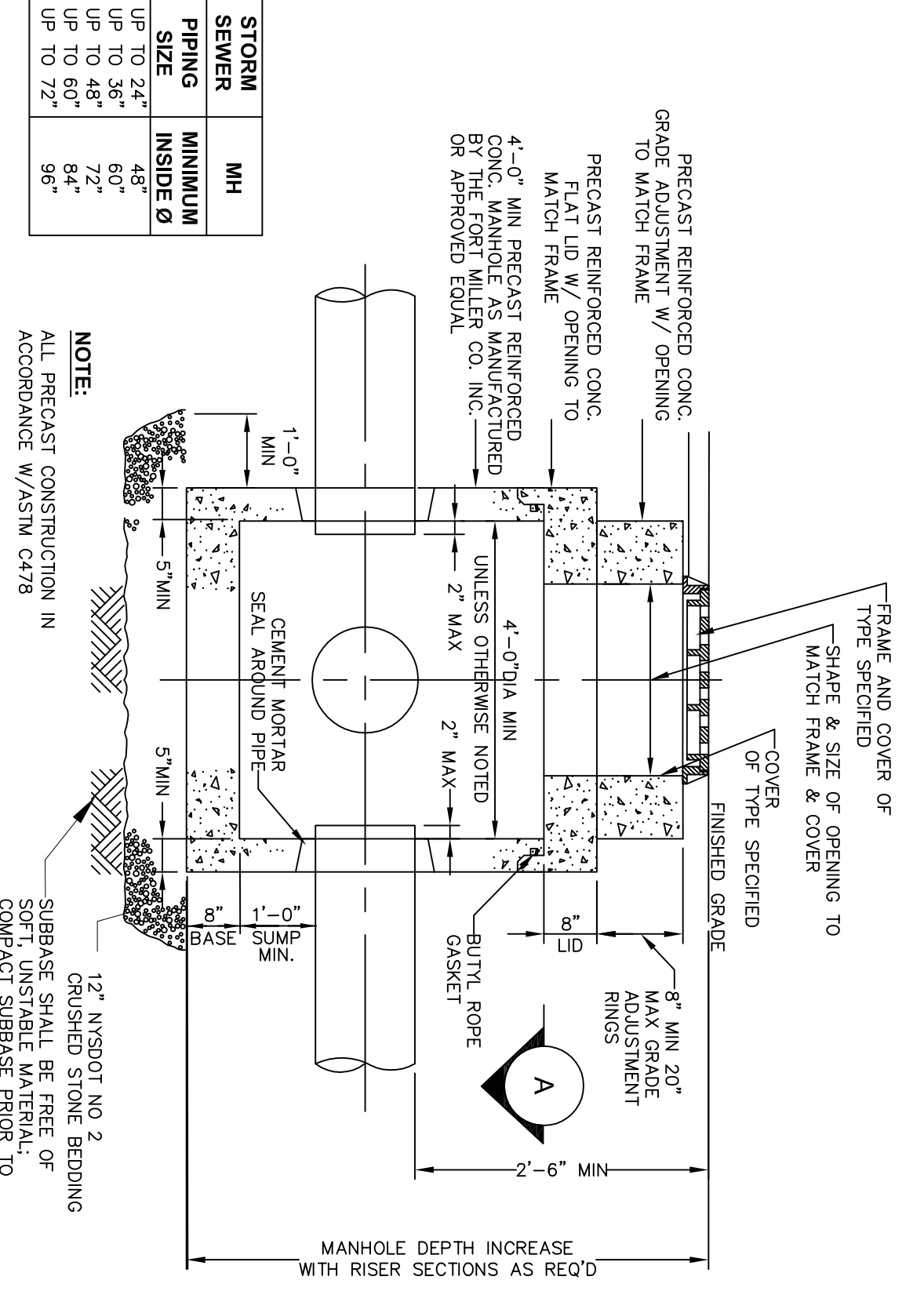

**PRECAST CONCRETE STORM SEWER
MANHOLE DETAIL**
NOT TO SCALE

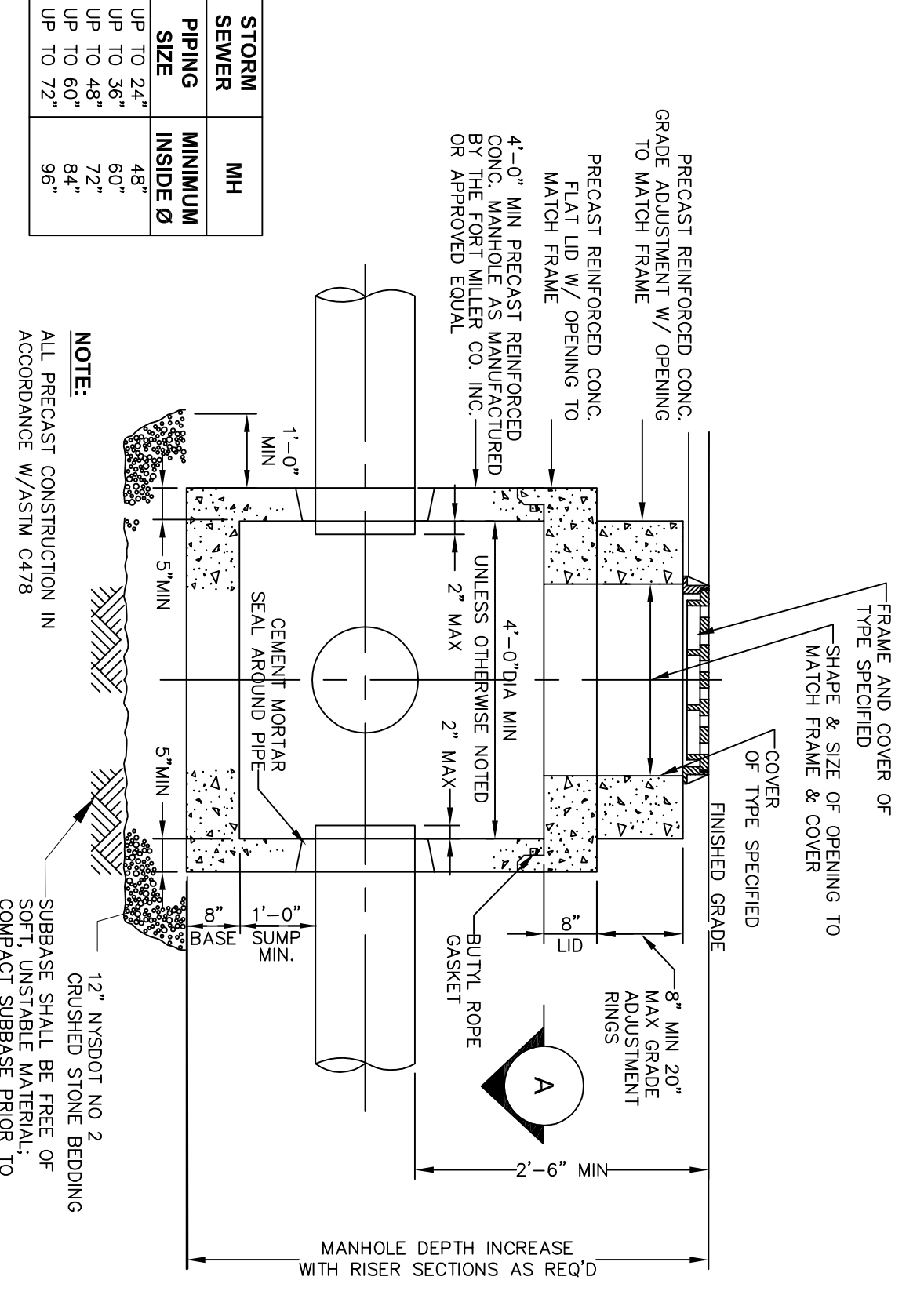

**PRECAST CONCRETE STORM SEWER
MANHOLE DETAIL**
NOT TO SCALE

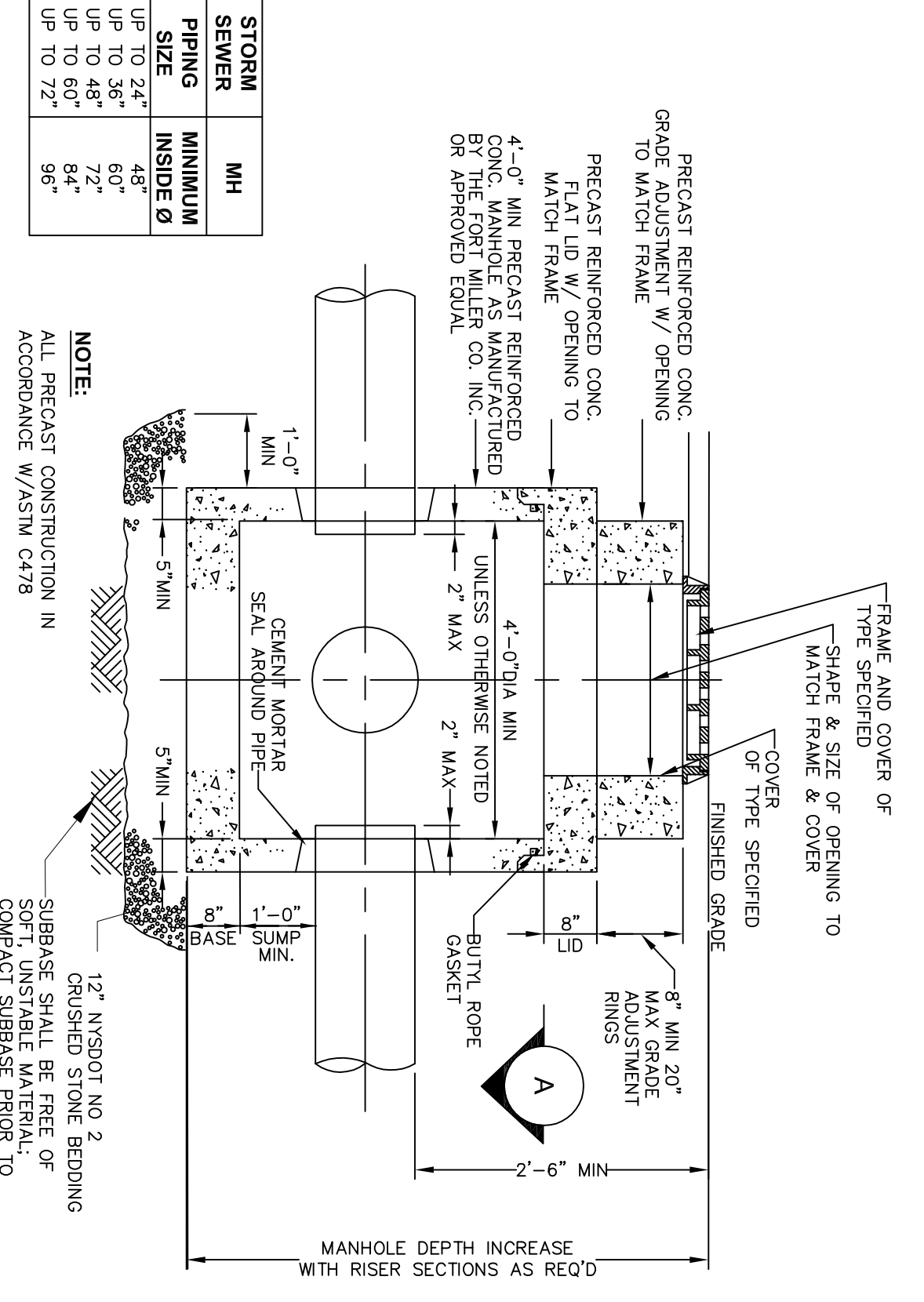

**PRECAST CONCRETE STORM SEWER
MANHOLE DETAIL**
NOT TO SCALE

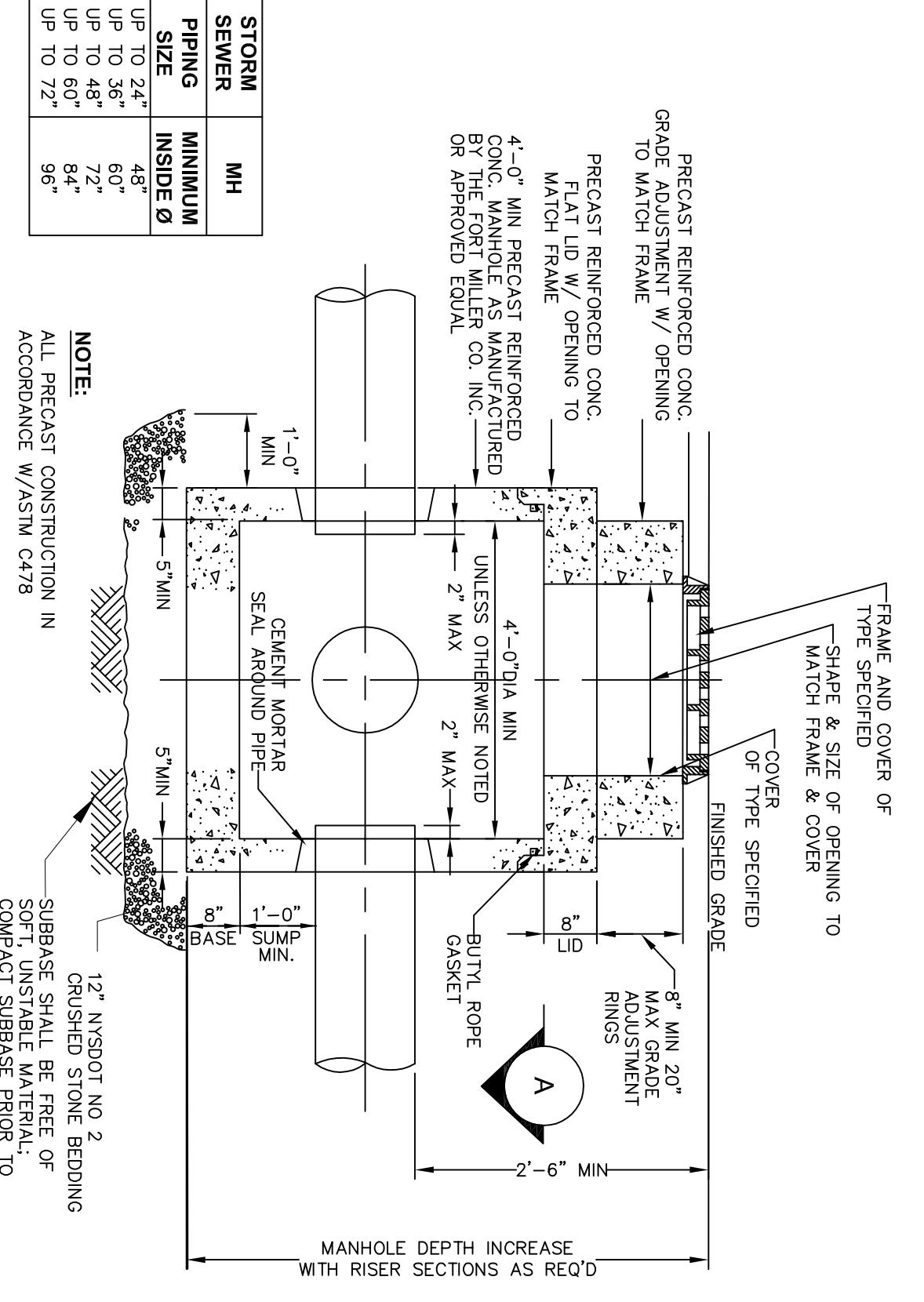

**PRECAST CONCRETE STORM SEWER
MANHOLE DETAIL**
NOT TO SCALE

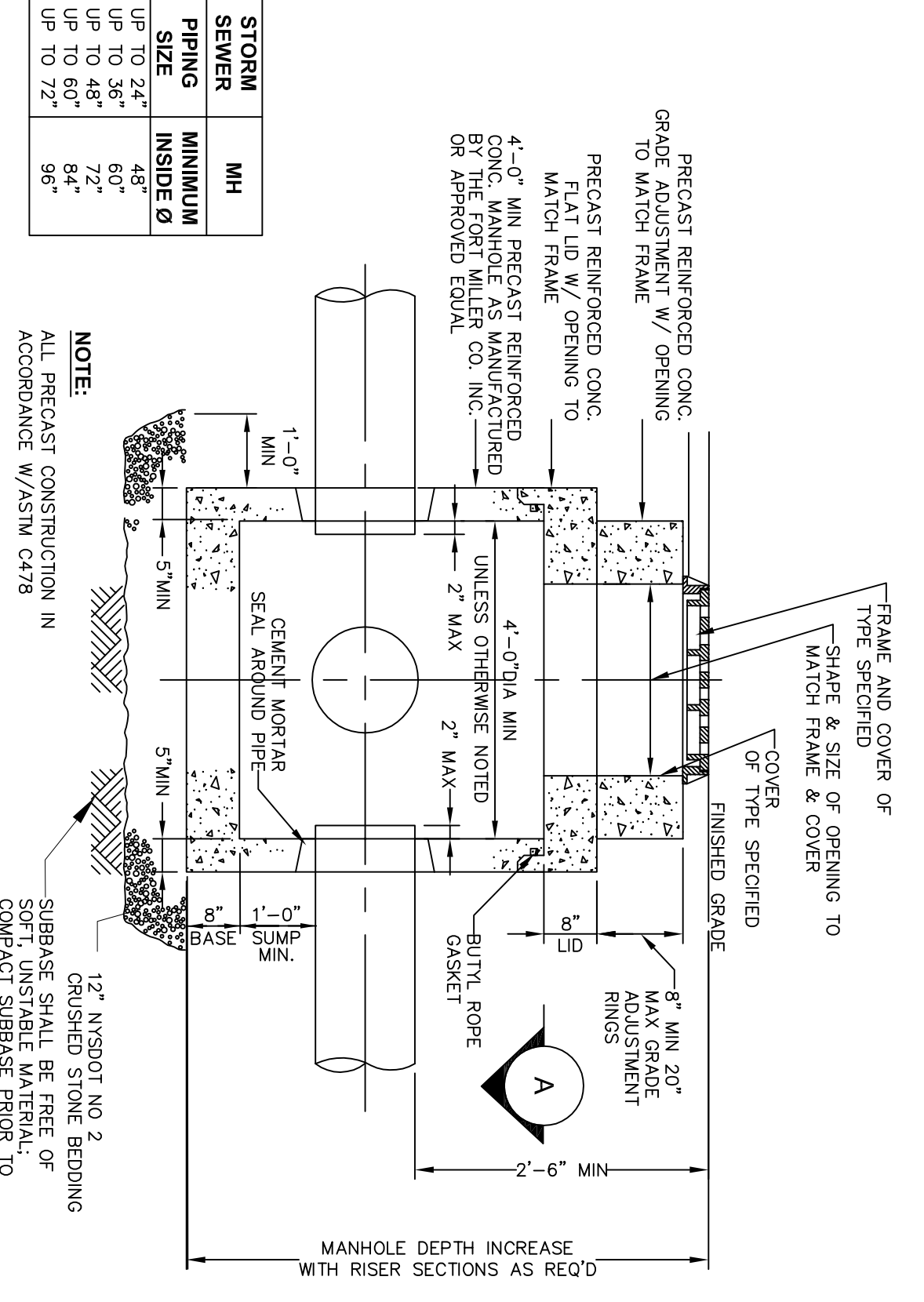

**PRECAST CONCRETE STORM SEWER
MANHOLE DETAIL**
NOT TO SCALE

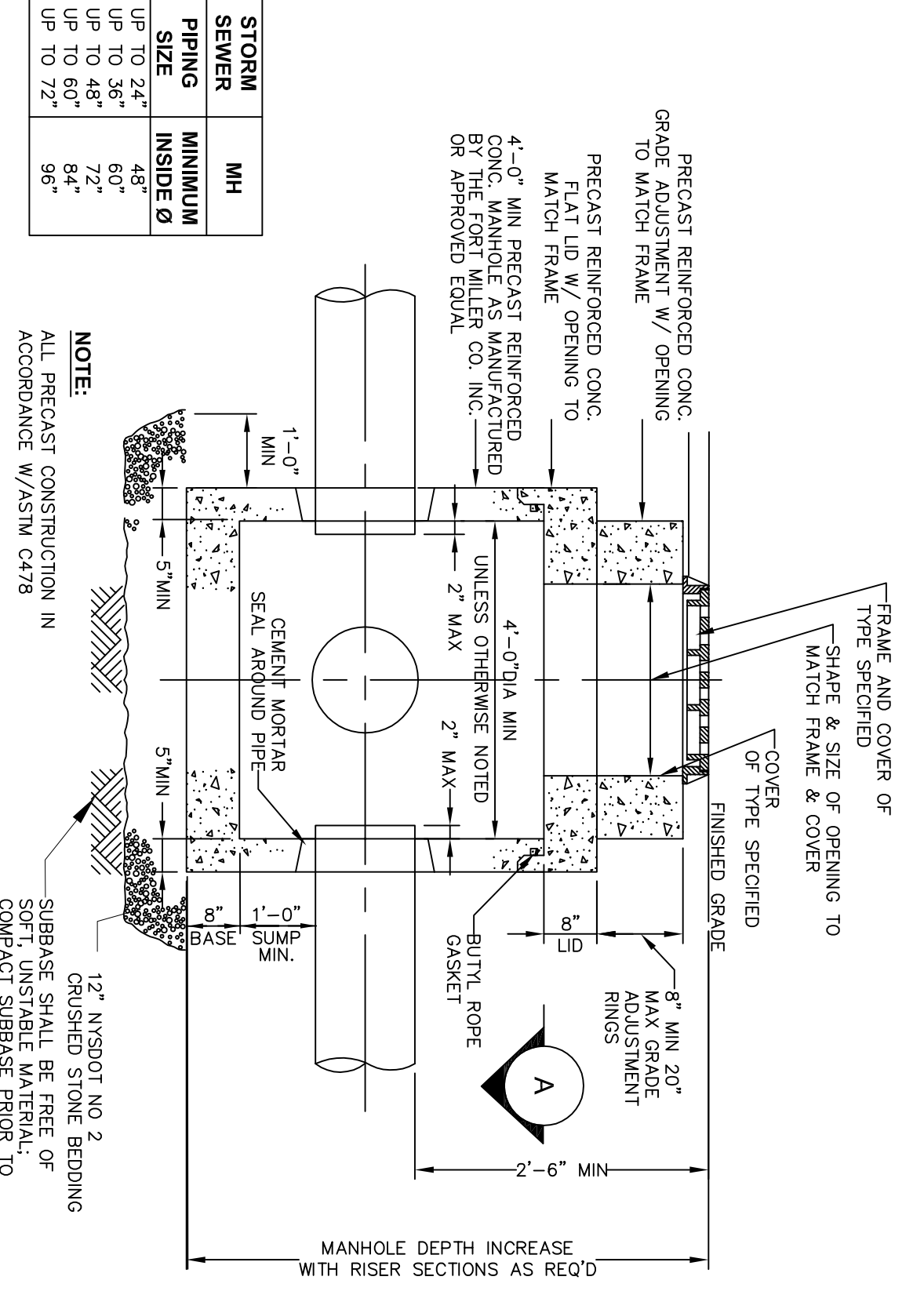

**PRECAST CONCRETE STORM SEWER
MANHOLE DETAIL**